

# Yealink

## Smart Business Phone

SIP-T58A with CAM50 & SIP-T58A

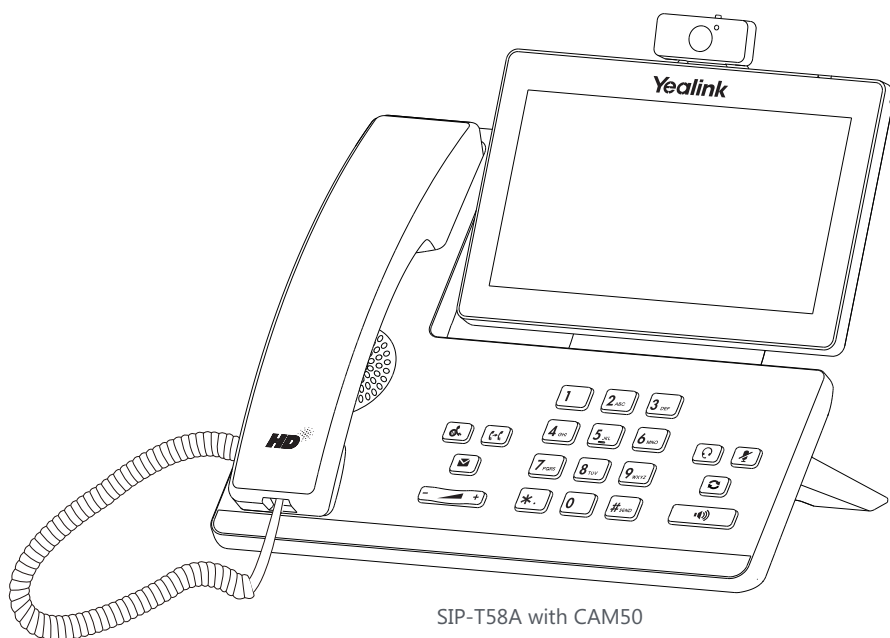

SIP-T58A with CAM50

## Quick Start Guide (V83.17)

## Package Contents

The following items are included in your package. If you find anything missing, contact your system administrator.

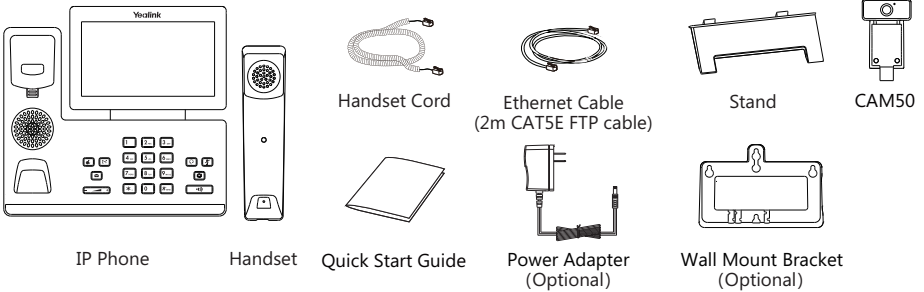

Note: The Yealink USB camera CAM50 is an optional accessory for the SIP-T58A IP phone. We recommend that you use the accessories provided or approved by Yealink. The use of unapproved third-party accessories may result in reduced performance.

## Assembling the Phone

### 1. Insert the camera, as shown below:

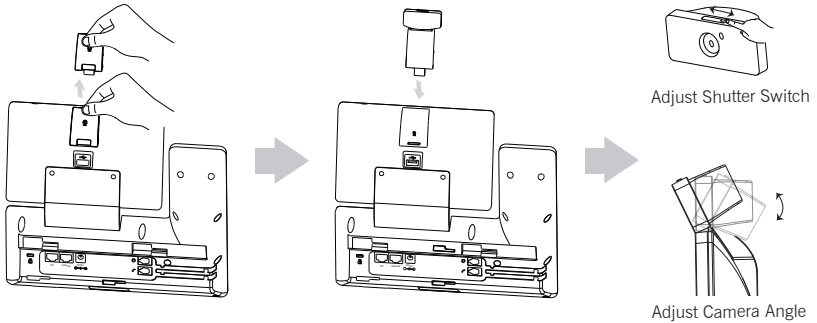

Note: The camera can only be connected to the USB port on the top of the phone. And the IP phone only supports the Yealink original USB camera CAM50.

### 2. Attach the stand and adjust the angle of touch screen, as shown below:

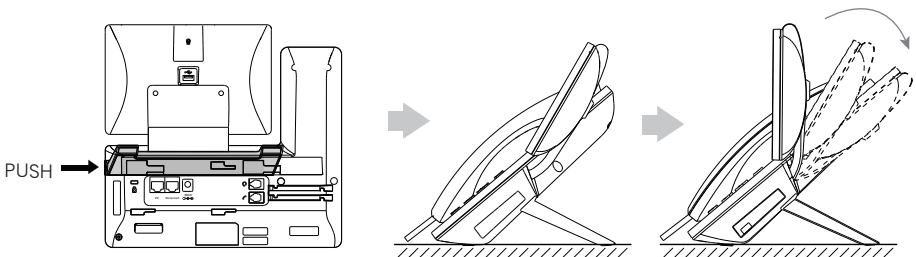

### 3. Attach the optional wall mount bracket, as shown below:

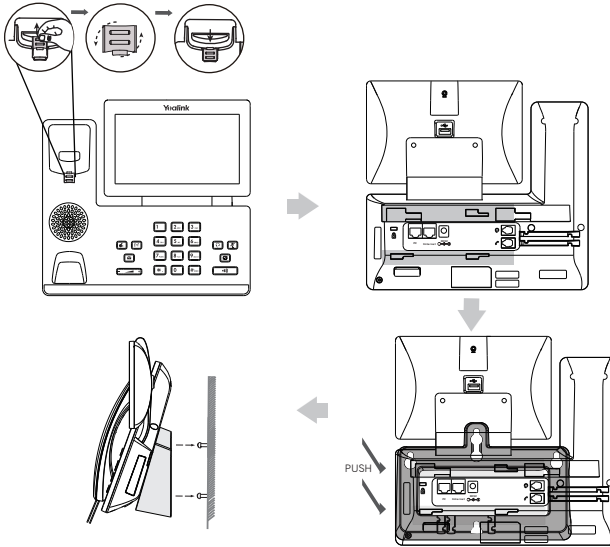

Note: The reversible tab has a lip which allows the handset to stay on-hook when the IP phone is mounted vertically. For more information, refer to Yealink Wall Mount Quick Installation Guide for Yealink IP Phones.

### 4. Connect the handset and optional headset, as shown below:

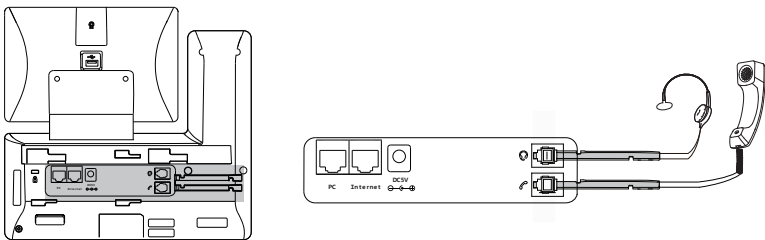

Note: The headset should be purchased separately.

### 5. Connect the optional USB flash drive, as shown below:

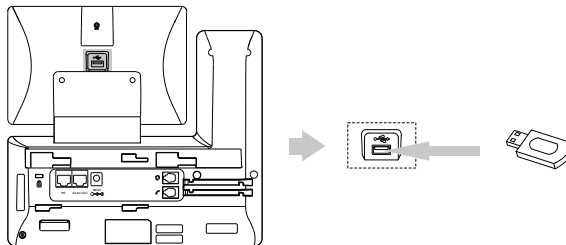

Note: The USB port (on the rear of the phone) can also be used to connect color-screen expansion module EXP50, USB headset or DECT USB dongle DD10K. For more information on how to use EXP50, refer to Yealink EXP50 User Guide. For more information on how to use USB headset, refer to the documentation from the manufacturer. For more information on how to use DD10K, refer to Yealink Smart Business Phones User Guide.

## 6. Connect the AC power or PoE, as shown below:

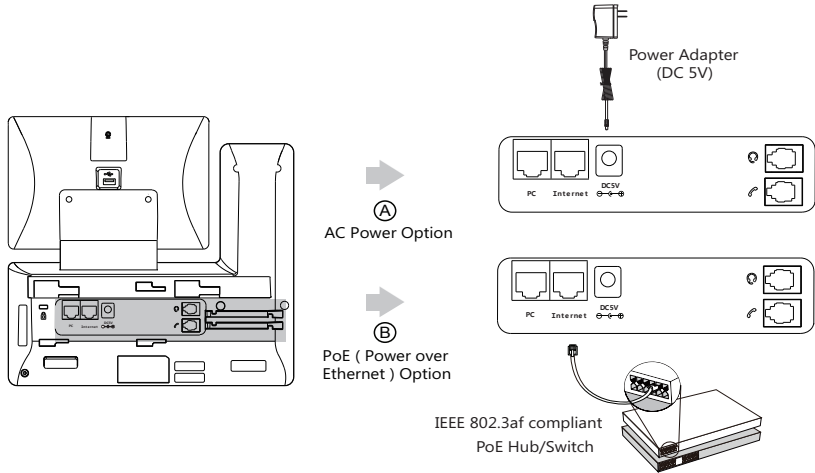

Note: The IP phone should be used with Yealink original power adapter (5V/2A) only. The use of the third-party power adapter may cause the damage to the phone.

## 7. Connect to the network, as shown below:

You have two options for network connection. You can select one of them according to the current office environment.

a) Connect to the wired network:

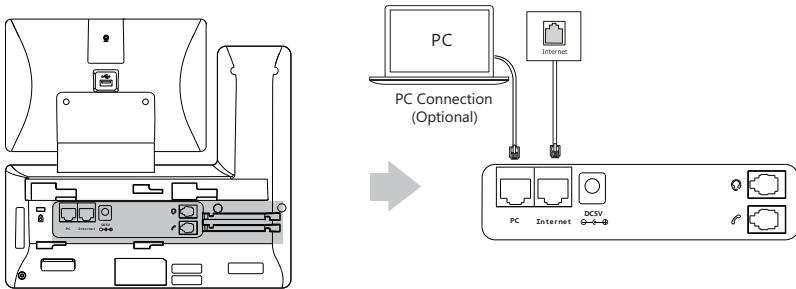

Note: If you are connecting a PC to your phone, we recommend that you use the Ethernet cable provided by Yealink.

b) Connect to the wireless network:

- 1) Swipe down from the top of the screen to enter the control center.
- 2) Tap **Setting**->**Basic**->**Wi-Fi**.
- 3) Tap the **On** radio box in the **Wi-Fi** field.  
The phone will automatically search for available wireless networks in your area.
- 4) Select an available wireless network from the list of networks.
- 5) If the network is secure, enter its password in the **Password** field.
- 6) Tap **Connect** to connect to the wireless network.

# Hardware Component Instructions

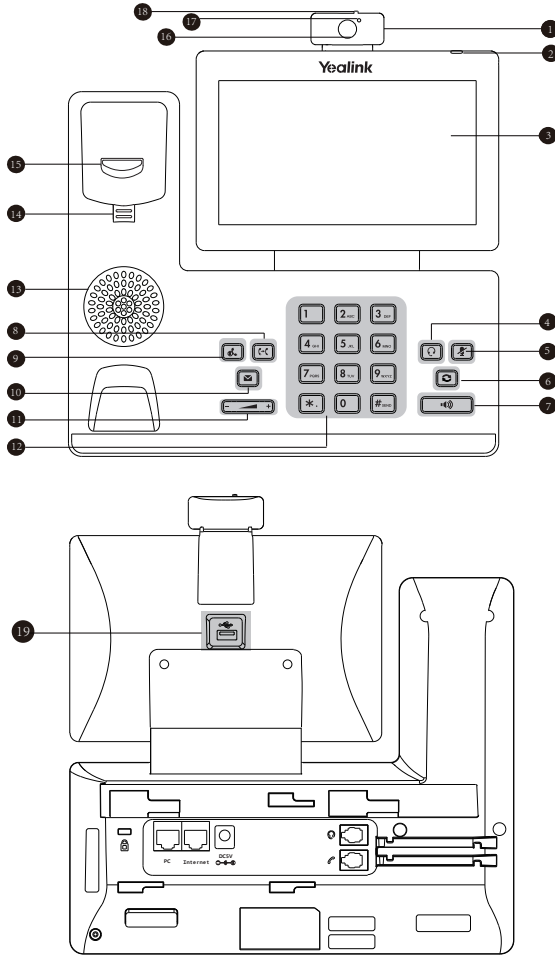

Item	Item	Item
1 Camera	8 TRANSFER Key	15 Hookswitch
2 Power Indicator LED	9 HOLD Key	16 Camera Lens
3 Touch Screen	10 MESSAGE Key	17 Camera Indicator LED
4 HEADSET Key	11 Volume Key	18 Shutter Switch
5 MUTE Key	12 Keypad	19 USB2.0 port
6 REDIAL Key	13 Speaker	
7 Speakerphone Key	14 Reversible Tab	

# Startup

After the IP phone is connected to the network and supplied with power, it automatically begins the initialization process. After startup, the phone is ready for use. You can configure the phone via web user interface or phone user interface.

Welcome

initializing... Please wait

## Configuring Your Phone

### Configuring via web user interface

#### Accessing the web user interface:

1. Swipe down from the top of the screen to enter the control center.
2. Tap **Setting**->**Status** to obtain the IP address of the phone.
3. Open a web browser on your computer, enter the IP address into the address bar (e.g., "http://192.168.0.10" or "192.168.0.10"), and then press **Enter**.
4. Enter the user name (default: admin) and password (default: admin) in the login page and click **Confirm**.

#### Network Settings: Click on **Network**->**Basic**->**IPv4 Config**

You can configure the network settings in the following ways:

**DHCP:** By default, the phone attempts to contact a DHCP server in your network to obtain its valid network settings, e.g., IP address, subnet mask, gateway address and DNS address.

**Static IP Address:** If the phone cannot contact a DHCP server for any reason, you need to configure IP address, subnet mask, gateway address, primary DNS address and secondary DNS address for the phone manually.

**PPPoE:** If you are using an xDSL modem, you can connect your phone to the Internet via PPPoE mode. Contact the ITSP for the PPPoE user name and password.

Note: The IP phone also supports IPv6, but IPv6 is disabled by default.

The wrong network settings may result in inaccessibility of your phone and may have an impact on the network performance. Contact your system administrator for more information.

**Account Settings:** Click on **Account**->**Register**->**Account X** (X=1,2,3...15,16)

#### Parameters of the account:

Register Status:	It shows the register status of the current account.
Line Active:	You can select Enabled/Disabled to enable/disable the account.
Label:	It is shown on the touch screen to identify the account.
Display Name:	It is shown as Caller ID when placing a call.
Register Name:	It is an authenticated ID for authentication provided by ITSP (required).
User Name:	It is provided by ITSP for registration (required).
Password:	It is provided by ITSP for registration (required).
Server Host:	It is provided by ITSP for registration (required).

## Register status icons on the touch screen:

 (Green) Registered

 (Gray) Register Failed

 (Green and Flashing) Registering

Note: Check with your system administrator if any error appears during the registration process or a specific configuration is required for your registration.

## Configuring via phone user interface

### Network Settings:

1. Swipe down from the top of the screen to enter the control center.
2. Tap **Setting**->**Advanced Settings** (default password: admin)->**Network**->**WAN Port/VLAN /Web Server/802.1x/VPN/LLDP/CDP/NAT** to configure the network.















### Account Settings:

1. Swipe down from the top of the screen to enter the control center.
2. Tap **Setting**->**Advanced Settings** (default password: admin)->**Accounts** to configure the account.

## Using Your Phone

### Status Icons

The icons on the status bar of the touch screen give information about phone:



Icons	Description
	Shows that camera is not detected.
 (White)	Shows that Wi-Fi is turned on.
 (Green)	Shows that the phone is connected to wireless network successfully.
	Shows that wired network is unavailable.
 (White)	Shows that Bluetooth is turned on.
 (Green)	Shows that Bluetooth headset is paired successfully.
 (Green)	Shows that Bluetooth-Enabled mobile phone is paired successfully.
	Shows that the phone is locked.
	Shows that "Forward" is turned on.
	Shows that "Do Not Disturb" is turned on.
	Shows that "Auto Answer" is turned on.
	Shows that you have missed calls.
	Shows that you have unread voice mails.
	Shows that "Silent" is turned on.
	Shows that a USB flash drive is detected.

## Using the Touch Screen

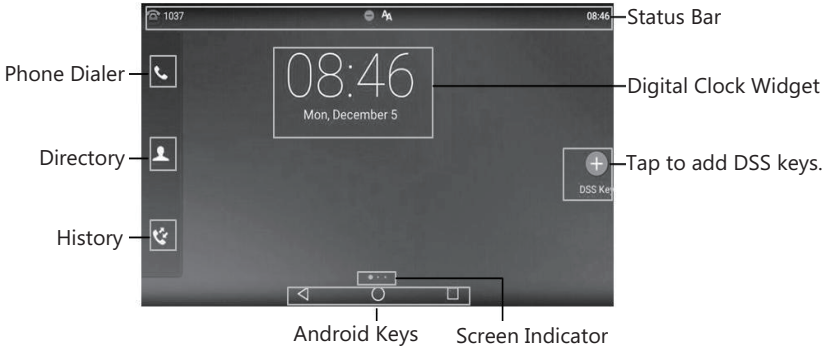
By default, the IP phone supports three idle screens. The home screen displays as below:



### To navigate the touch screen:

- Swipe left or right to switch among different idle screens.
- Tap  to go back to the previous screen.
- Tap  to return to the idle screen.
- Tap  to view and manage recently used applications.

### To change the wallpaper:

1. Long tap the empty spot on the idle screen.
2. Tap **WALLPAPERS**.
3. Select a desired picture.
4. Tap **Set wallpaper**.

### To add a widget to the idle screen:

1. Long tap the empty spot on the idle screen.
2. Tap **WIDGETS**.
3. Drag the desired widget up/down/left/right to the destination spot on the idle screen.

## Control Center and Notification Center

Swipe down from the top of the screen to enter the control center and the notification center.

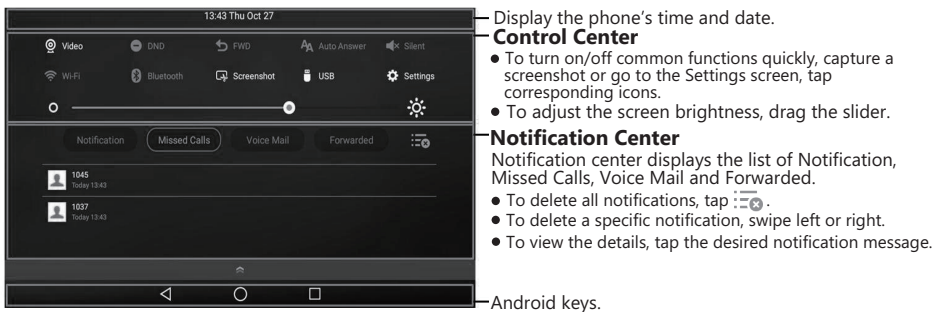

Swipe up from the bottom of the screen to hide this screen.



## Entering and Updating Data

### To use onscreen keyboard:

1. Tap the input field, the onscreen keyboard will display on the touch screen:



Tap to access input options to configure Input Languages or Android Keyboard Settings(AOSP).

2. When you finish entering, tap  to hide the onscreen keyboard.

### To use keypad:

Dial or enter number.

### To select a field option:

Tap the field name, tap the desired option in the pop-up dialog box.

## Basic Call Features

### Placing a Video/Voice Call

#### Using the handset:

1. Pick up the handset.
2. Enter the number, and then tap **Send**.

#### Using the speakerphone:

1. With the handset on-hook, press  .
2. Enter the number, and then tap **Send**.

#### Using the headset:

1. With the headset connected, press  to activate the headset mode.
2. Enter the number, and then tap **Send**.

### Answering a Video/Voice Call

#### Using the handset:

Pick up the handset.

#### Using the speakerphone:

Press  .

#### Using the headset:

Press  .

### Controlling Video During a Call

#### To change the video view:

- Tap **Full Screen** to display the video in full screen.
- Tap  to return.

#### To turn on/off near-site video during a call:

Swipe down from the top of the screen to enter the control center, tap **Video** to turn on/off the near-site video.

---

## Ending a Video/Voice Call

### Using the handset:

Hang up the handset or tap the **End Call** soft key.



### Using the speakerphone:

Press  or tap the **End Call** soft key.



### Using the headset:

Tap the **End Call** soft key.

## Redial

- Press  to enter the **Placed Calls** list, and then tap the desired entry.
- Press  twice when the phone is idle to dial out the last dialed number.

## Call Mute and Un-mute



- Press  to mute the microphone during a call.
- Press  again to un-mute the call.

## Call Hold and Resume

### To place a call on hold:

Press  or tap the **Hold** soft key during an active call.



### To resume the call, do one of the following:

- If there is only one call on hold, press  or tap the **Resume** soft key.
- If there is more than one call on hold, tap the call you want to resume, and press  or tap the **Resume** soft key.



## Call Transfer

You can transfer a call in the following ways:



### Blind Transfer

1. Press  or tap the **Transfer** soft key during a call. The call is placed on hold.
2. Enter the number you want to transfer to.
3. Press .

### Semi-Attended Transfer

1. Press  or tap the **Transfer** soft key during a call. The call is placed on hold.
2. Enter the number you want to transfer to, and then press .
3. Press  or tap the **Transfer** soft key when you hear the ring-back tone.

### Attended Transfer

1. Press  or tap the **Transfer** soft key during a call. The call is placed on hold.
2. Enter the number you want to transfer to, and then press .
3. Press  or tap the **Transfer** soft key when the second party answers.

## Call Forward

### To enable call forward:

1. Swipe down from the top of the screen to enter the control center.
2. Tap **Settings**->**Features**->**Call Forward**.
3. Select the desired forward type:
  - Always Forward**----Incoming calls are forwarded unconditionally.
  - Busy Forward**----Incoming calls are forwarded when the phone is busy.
  - No Answer Forward**----Incoming calls are forwarded if not answered after a period of time.
4. Enter the number you want to forward to. For **No Answer Forward**, tap the **After Ring Time** field, and then tap the desired ring time to wait before forwarding.
5. Tap  to accept the change.

## Call Conference

1. Tap the **Conference** soft key during an active call. The call is placed on hold.
2. Enter the number of the second party, and then press  or tap **Conference**.
3. Tap the **Conference** soft key again when the second party answers. All parties are now joined in the conference.
4. Tap the **End Call** soft key to disconnect all parties.

Note: You can split the conference call into two individual calls by tapping the **Split** soft key.

## Voice Message



Message waiting indicator on the idle screen indicates that one or more voice messages are waiting at the message center. The power indicator LED slowly flashes red.

**To listen to voice messages:** (Ensure the voice mail code is already configured on the phone.)

1. Do one of the following:
  - Press .
  - Swipe down from the top of the screen to enter the notification center, tap **Voice Mail** and then select the desired item.
2. Follow the voice prompts to listen to your voice messages.



## Customizing Your Phone

### Call History



1. Tap , and then select the desired call list on the left.
2. Drag up and down to scroll.
3. Tap  after the desired entry, and then you can do the following:
  - Tap **Send** to place a call.
  - Tap **Add** to add the entry to the local directory.
  - Tap **Edit** to edit the phone number of the entry before placing a call.
  - Tap **Blacklist** to add the entry to the blacklist.
  - Tap **Delete** to delete the entry from the list.

### Contact Directory



#### To add a contact:

1. Tap , and then select the desired group on the left.
2. Tap  to add a contact.
3. Enter a unique contact name in the **Name** field and contact numbers in the corresponding fields.
4. Tap  to accept the change.

#### To edit a contact:



1. Tap , and then select the desired group on the left.
2. Tap  after the desired contact.
3. Edit the contact information.
4. Tap  to accept the change.

#### To delete a contact:

1. Tap , and then select the desired group on the left.
2. Tap  after the desired contact and then tap **Delete**.
3. Tap **OK** when the touch screen prompts "Delete selected item?".

Note: You can add contacts from call history easily. For more information, refer to **Call History** above.

## Volume Adjustment

- Press  during a call to adjust the receiver volume of the handset/speakerphone/headset.
- Press  when the phone is idle or ringing to adjust the ringer volume.
- Press  to adjust the media volume in the corresponding screen.

## Regulatory Notices

### Operating Ambient Temperatures

- Operating temperature: +32 to 104°F (0 to 40°C)
- Relative humidity: 5% to 90%, noncondensing
- Storage temperature: -22 to +160°F (-30 to +70°C)

### Warranty

Our product warranty is limited only to the unit itself, when used normally in accordance with the operating instructions and the system environment. We are not liable for damage or loss resulting from the use of this product, or for any claim from a third party. We are not liable for problems with Yealink device arising from the use of this product; we are not liable for financial damages, lost profits, claims from third parties, etc., arising from the use of this product.

### Explanation of the symbols

#### ● DC symbol

— is the DC voltage symbol.

#### ⚠ WEEE Warning symbol

To avoid the potential effects on the environment and human health as a result of the presence of hazardous substances in electrical and electronic equipment, end users of electrical and electronic equipment should understand the meaning of the crossed-out wheeled bin symbol. Do not dispose of WEEE as unsorted municipal waste and have to collect such WEEE separately.

### Restriction of Hazardous Substances Directive (RoHS)

This device complies with the requirements of the EU RoHS Directive. Statements of compliance can be obtained by contacting support@yealink.com.

### Safety Instructions

Save these instructions. Read these safety instructions before use!

#### ⚠ General Requirements

- Before you install and use the device, read the safety instructions carefully and observe the situation during operation.
- During the process of storage, transportation, and operation, please always keep the device dry and clean, avoid collision and crash.
- Please attempt not to dismantle the device by yourself. In case of any discrepancy, please contact the appointed maintenance center for repair.
- Please refer to the relevant laws and statutes while using the device. Legal rights of others should be respected as well.

#### ⚠ Environmental Requirements

- Place the device at a well-ventilated place. Do not expose the device under direct sunlight.
- Keep the device dry and free of dusts.
- Do not place the device on or near any inflammable or fire-vulnerable object, such as rubber-made materials.
- Keep the device away from any heat source or bare fire, such as a candle or an electric heater.

#### ⚠ Operating Requirements

- Do not let a child operate the device without guidance.
- Do not let a child play with the device or any accessory in case of accidental swallowing.
- Please use the accessories provided or authorized by the manufacturer only.
- The power supply of the device shall meet the requirements of the input voltage of the device. Please use the provided surge protection power socket only.
- Before plugging or unplugging any cable, make sure that your hands are completely dry.
- Do not spill liquid of any kind on the product or use the equipment near water, for example, near a bathtub, washbowl, kitchen sink, wet basement or near a swimming pool.
- During a thunderstorm, stop using the device and disconnect it from the power supply. Unplug the power plug and the Asymmetric Digital Subscriber Line (ADSL) twisted pair (the radio frequency cable) to avoid lightning strike.

## About Yealink

Yealink is a global leading provider of enterprise communication and collaboration solutions, offering video conferencing service to worldwide enterprises. Focusing on research and development, Yealink also insists on innovation and creation. With the outstanding technical patents of cloud computing, audio, video and image processing technology, Yealink has built up a panoramic collaboration solution of audio and video conferencing by merging its cloud services with a series of endpoints products. As one of the best providers in more than 140 countries and regions including the US, the UK and Australia, Yealink ranks No.1 in the global market share of SIP phones shipments.

## Technical Support

Visit Yealink WIKI (<http://support.yealink.com/>) for the latest firmware, guides, FAQ, Product documents, and more. For better service, we sincerely recommend you to use Yealink Ticketing system (<https://ticket.yealink.com>) to submit all your technical issues.



T58A+CAM50/ T58A- EN

- If the device is left unused for a rather long time, disconnect it from the power supply and unplug the power plug.
- When there is smoke emitted from the device, or some abnormal noise or smell, disconnect the device from the power supply, and unplug the power plug immediately.
- Contact the specified maintenance center for repair.
- Do not insert any object into equipment slots that is not part of the product or auxiliary product.
- Before connecting a cable, connect the grounding cable of the device first. Do not disconnect the grounding cable until you disconnect all other cables.

#### ⚠ Cleaning Requirements

- Before cleaning the device, disconnect it from the power supply.
- Use a piece of soft, dry and anti-static cloth to clean the device.
- Keep the power plug clean and dry.

### Troubleshooting

The unit cannot supply power to Yealink device.

There is a bad connection with the plug.

1. Clean the plug with a dry cloth.

2. Connect it to another wall outlet.

The usage environment is out of operating temperature range.

1. Use in the operating temperature range.

The cable between the unit and the Yealink device is connected incorrectly.

1. Connect the cable correctly.

You cannot connect the cable properly.

1. You may have connected a wrong Yealink device.

2. Use the correct power supply.

Some dust, etc., may be in the port.

1. Clean the port.

Contact your dealer or authorized service facility for any further questions.

### FCC Statement

This device complies with part 15 of the FCC Rules. Operation is subject to the following

two conditions: (1) this device may not cause harmful interference, and (2) this device must accept any interference received, including interference that may cause undesired operation.

Any Changes or modifications not expressly approved by the party responsible for compliance could void the user's authority to operate the equipment.

### IC Statement

This device complies with Industry Canada's licence-exempt RSSs. Operation is subject to the following two conditions:

(1) this device may not cause interference; and

(2) this device must accept any interference, including interference that may cause undesired operation of the device. CAN ICES-3(B)

Le présent appareil est conforme aux CNR d'Industrie Canada applicables aux appareils radio exempts de licence. L'exploitation est autorisée aux deux conditions suivantes :

(1) l'appareil ne doit pas produire de brouillage;

(2) l'utilisateur de l'appareil doit accepter tout brouillage radioélectrique subi, même si le brouillage est susceptible d'en compromettre le fonctionnement. NMB-3(B)

### Radiation Exposure Statement

This equipment complies with FCC and IC radiation exposure limits set forth for an uncontrolled environment. This equipment should be installed and operated with minimum distance 20cm between the radiator and your body.

Cet équipement ne doit pas être Co-placé ou ne fonctionnant en même temps qu'aucune autre antenne ou émetteur. Cet équipement devrait être installé et actionné avec une distance minimum de 20 centimètres entre le radiateur et votre corps.

### Contact Information

YEALINK NETWORK TECHNOLOGY CO.,LTD.

309, 3rd Floor, No.16, Yun Ding North Road, Huli District, Xiamen City, Fujian, P.R. China

YEALINK (EUROPE) NETWORK TECHNOLOGY B.V.

Strawinskylaan 3127, Atrium Building, 8th floor, 1077ZX Amsterdam, The Netherlands

YEALINK (USA) NETWORK TECHNOLOGY CO., LTD.

999 Peachtree Street Suite 2300, Fulton, Atlanta, GA, 30309, USA

Made in China



YEALINK(XIAMEN) NETWORK TECHNOLOGY CO.,LTD.

Web: [www.yealink.com](http://www.yealink.com)

Copyright©2019 YEALINK(XIAMEN) NETWORK TECHNOLOGY CO.,LTD.All rights reserved.