

# Operation Manual

## Pure Sine Wave Inverter

**300/600/1000/1600/2500/3500W**

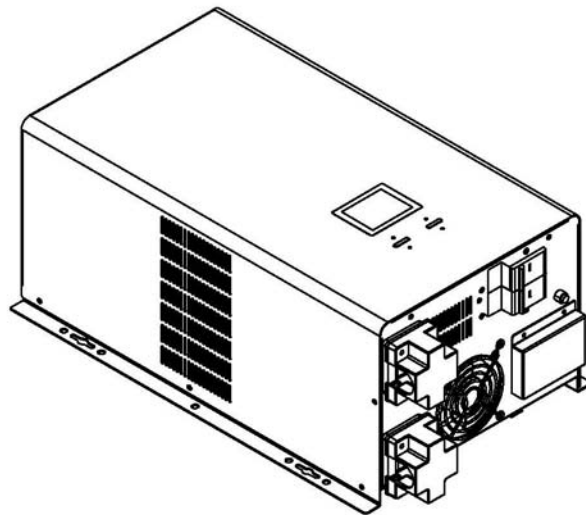
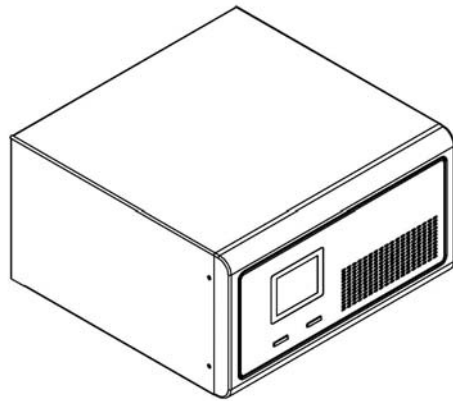

# 1 Safety Information



## CAUTION

Non-qualified electricians are forbidden to open the case due to hazard of electrical shock.

Consulting the dealer is required before using for below equipment. Its application, configuration, management and maintenance must be specially considered and designed.

- Medical equipment which is directly related to patients'life
- Elevator and other equipment which may endanger personal safety



### General safety and cautions

- Read all safety information and operating instructions carefully before using this inverter.
- Do not disassemble this inverter. Contact your local service center if maintenance or repair is needed.
- Disconnect all connection wiring before maintenance or cleaning to avoid the risk of electric shock.
- Do not use liquid extinguisher if there is a fire, a dry powder extinguisher is recommended.
- Do not dispose of the batteries with fire. The batteries may explode.
- Do not open or mutilate batteries. Released electrolyte inside is harmful to the skin and eyes, and maybe toxic.
- Do not connect the positive pole and negative pole directly, otherwise it will cause electric shocks or will be on fire.

## 2 Product Overview

### 2.1 Specifications

MODEL	300W	600W	1000W	1600W	2500W	3500W
<b>DC Input</b> (the inverter must be connected to batteries to work properly)						
Nominal input voltage	12V			24V		
DC input range	10 ~ 15V			20 ~ 30V		
<b>AC Input</b>						
Bypass input range	0 ~ 264Vac for 220Vac/230Vac/240Vac, 0 ~ 132Vac for 100Vac/110Vac/120Vac					
Mains input range	150 ~ 282Vac for 220Vac, 156 ~ 294Vac for 230Vac, 163 ~ 307Vac for 240Vac 68 ~ 128Vac for 100Vac, 75 ~ 141Vac for 110Vac, 82 ~ 154Vac for 120Vac					
Input frequency range	50Hz / 60Hz (Auto-sense), 45 ~ 55Hz for 50Hz, 55 ~ 65Hz for 60Hz					
Input range of the generator	99 ~ 282Vac for 220Vac, 104 ~ 294Vac for 230Vac, 108 ~ 307Vac for 240Vac 45 ~ 128Vac for 100Vac, 50 ~ 141Vac for 110Vac, 54 ~ 154Vac for 120Vac No AVR in generator mode					
Input frequency range of the generator	40 ~ 70Hz					
Input power matching of the generator	Rated power 10% ~ 120%, regulating step 10% , default 120%					
<b>Output</b>						
Inverter output range	220V / 230V / 240Vac $\pm$ 5% or 100V / 110V / 120Vac $\pm$ 5% (settable)					
Bypass output range	0 ~ 264Vac for 220V/230V/240V, 0 ~ 132Vac for 100V/110V/120V					
Mains output range	174 ~ 242Vac for 220Vac, 182 ~ 253Vac for 230Vac, 190 ~ 264Vac for 240Vac 79 ~ 109Vac for 100Vac, 87 ~ 121Vac for 110Vac, 95 ~ 133Vac for 120Vac					
Output frequency	50Hz / 60Hz $\pm$ 0.3 (Auto-sense & settable)					
Output waveform	Pure sine wave					
Output power	300W	600W	1000W	1600W	2500W	3500W
Efficiency	Max. 95% (Mains mode); Max. 80% (Inverter mode)					
ECO mode	Settable, enter in 80 s					
No-load shutdown	Settable, shutdown in 80 s					
Load rate in ECO mode / No-load shutdown	Settable, 3% ~ 50% optional, default 3%					

Transfer time	≤ 10 ms			≤ 15 ms		
Power factor	1.0					
THDV	< 5% (linear load)					
Inductive load	Yes					
Motor load	Yes					
Rectifier load	Yes					
Overload capability	Mains mode: 110% 120 s, 125% 60 s, 150% 10 s (switch to bypass) Inverter mode: 110% 60s; 125% 10 s; 150% 0.7 s (shut down)					
<b>Battery</b>						
Charging current (selectable)	Default 10A	Default 20A, regulating step 1A (< 10A) / 5A (> 10A)				
	Max. 15A	Max. 30A	Max. 40A	Max. 40A	Max. 50A	Max. 60A
Equalizing charge voltage	Single battery 14.1Vdc (default), 13.6 ~ 15Vdc settable					
Floating charge voltage	Single battery 13.5Vdc (default), 13.2 ~ 14.6Vdc settable					
EOD	Single battery 10.2Vdc (default), 9.6 ~ 11.5Vdc settable					
Reverse warning	Buzzer					
<b>Alarm</b>						
Switch on / off	Continuous beep 2 s					
Low battery	Beep 0.2 s at interval of 0.4 s					
Overload	Beep 2 s at interval of 2.5 s					
Mains power abnormal	Beep 0.3 s at interval of 5 s					
<b>Others</b>						
Protections	Overload – short-circuit – low battery – overcharge – overtemperature					
Interface	LCD & BUZZER					
Operating temperature	0°C ~ 40°C					
Operating humidity	Relative humidity ≤ 93%					
Altitude	< 1000m, (above 1000m, derating 1% for each additional 100 m), 4000 m max.					
Net weight (kg)	8.3	11.3	14.0	20.2	32.0	36.0
Gross weight (kg)	9.3	12.3	15.0	21.2	34.0	38.0
Dimensions (W×D×H) mm	293×280×160				302×479×209	
Packaged dimensions (W×D×H) mm	370×355×235				353×582×287	

Note: Specifications are subject to change without notice

## Charging features

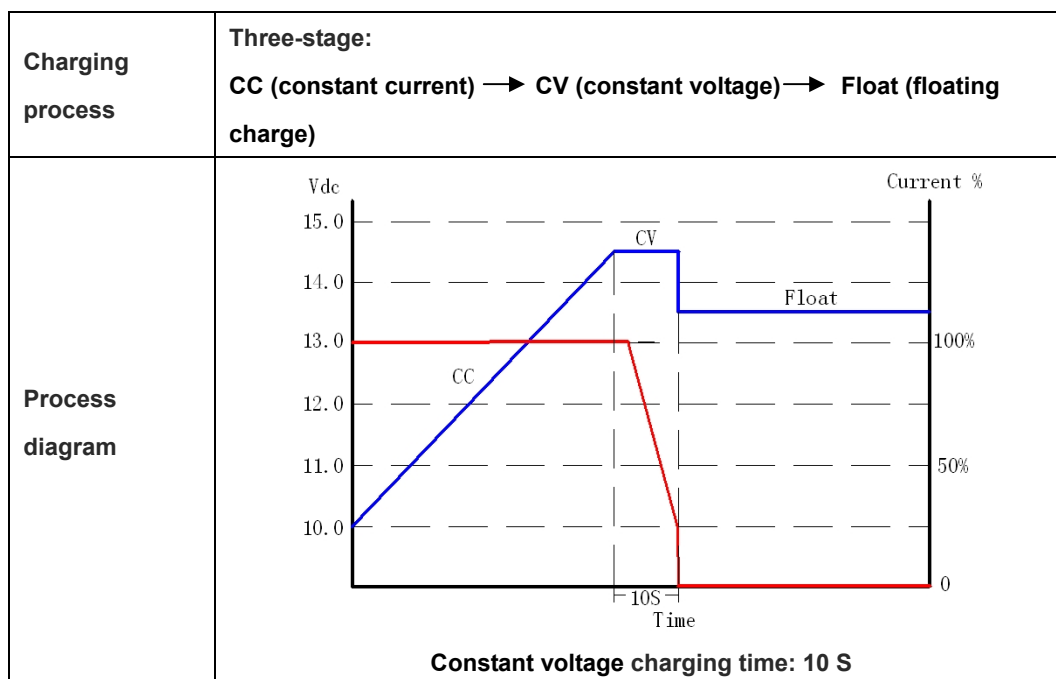

## 2.2 Front panel features

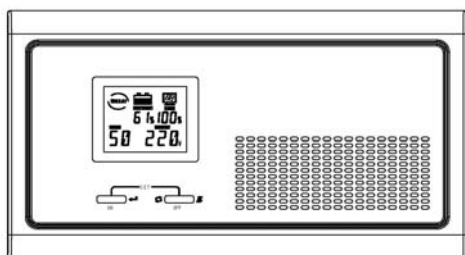

300W ~ 1600W front panel

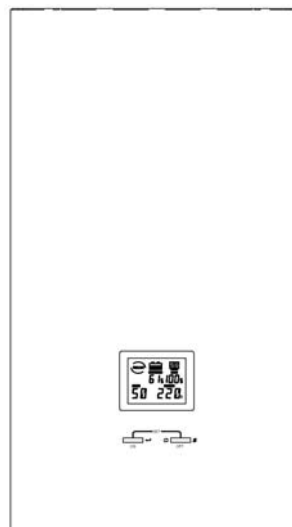

2500W ~ 3500W front panel

## 2.3 Rear panel features

### 300W ~ 1600W rear panel

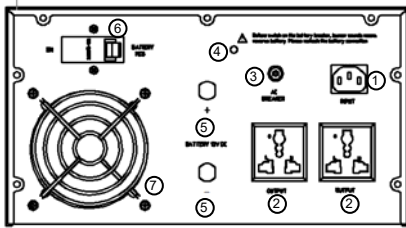

- ① AC input socket
- ② Output sockets
- ③ Overcurrent protector
- ④ Buzzer for battery reverse
- ⑤ Battery wiring
- ⑥ Battery breaker
- ⑦ Fan

### 2500W ~ 3500W rear panel

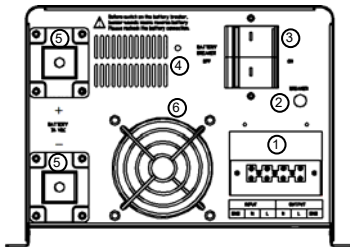



- ① Input / output terminal block
- ② Overcurrent protector
- ③ Battery breaker
- ④ Buzzer for battery reverse
- ⑤ Battery wiring terminal
- ⑥ Fan

### 3 Installation Instructions

#### 3.1 Unpacking Inspection

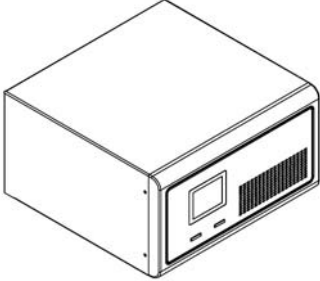
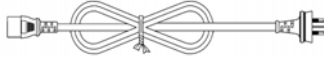
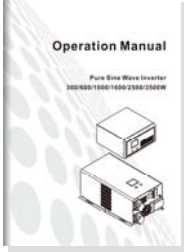
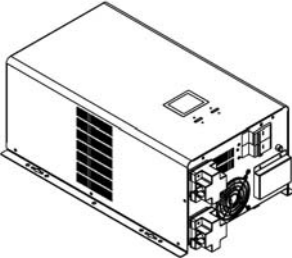
Inspect the contents upon receipt. Notify the carrier and dealer if the unit is damaged.

300W ~ 1600W package contents		
 <p>300W ~ 1600W Inverter</p>	 <p>AC input power cords</p>	 <p>Operation manual</p>
2500W ~ 3500W package contents		
 <p>2500W ~ 3500W Inverter</p>	 <p>Operation manual</p>	

#### 3.2 Installation

 <b>CAUTION</b>
The inverter is designed for indoor use. Do not operate this UPS in direct sunlight, in contact with fluids, or where there is excessive dust or humidity.
Place batteries in sound ventilation environment.
Use insulated tools to reduce the risk of short-circuit when installing or working with the inverter, the batteries, or other equipments attached to this unit.
Be sure that the ground terminal has been connected with the ground.

### 3.2.1 Installation information

- Inspect whether the battery voltage and Mains voltage are correct or not.
- Connect the inverter with batteries, utility power and loads. Be sure all wiring is correct, terminals are screwed tightly and terminal cover is locked.
- Open the battery breaker, press ON button, then the inverter starts up in 3 seconds, and then check if the load has problem (overload, short-circuit ect.). If it does, check and correct until confirming it is normal, and then connect to the utility power.

### 3.2.2 Connect external battery

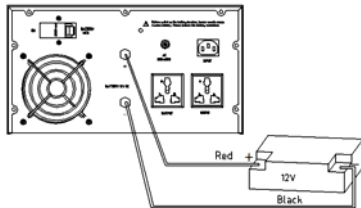

300W / 600W / 1000W DC12V inverter battery connection diagram

(Note that the red cable is connected to the positive terminal, black cable is connected to the negative terminal)

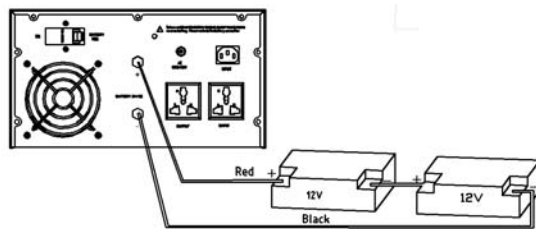

1600W DC24V inverter battery connection diagram

(Note that the red cable is connected to the positive terminal, black cable is connected to the negative terminal)

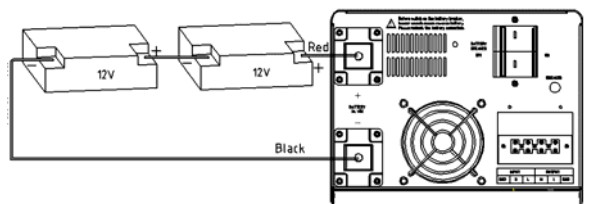

2500W / 3500W DC24V inverter battery connection diagram

(Note that the red cable is connected to the positive terminal, black cable is connected to the negative terminal, and 2500W battery cable is more than 35mm<sup>2</sup>, 3500W battery cable is more than 50mm<sup>2</sup>)



## 4 Operations

### CAUTION

Turn on the inverter in battery mode first. Be sure that the load has no problem (overload, short-circuit ect.) before connecting to utility power.

#### 4.1 Turn the inverter On/Off

- Without connecting to utility power, press and hold “ON” button for 3 seconds, release it until the buzzer beeps, the inverter starts up. In the process of the inverter running, press and hold “OFF” button for 3 seconds, release it until the buzzer beeps, the inverter is shut down.
- When the inverter works in mains power / AC mode, press and hold “OFF” button for 3 seconds, release it until the buzzer beeps, the inverter goes to bypass mode.
- When the inverter works in bypass mode, press and hold “ON” button for 3 seconds, release it until the buzzer beeps, the inverter goes to AC mode.

#### 4.2 Display interface

##### Inverter mode

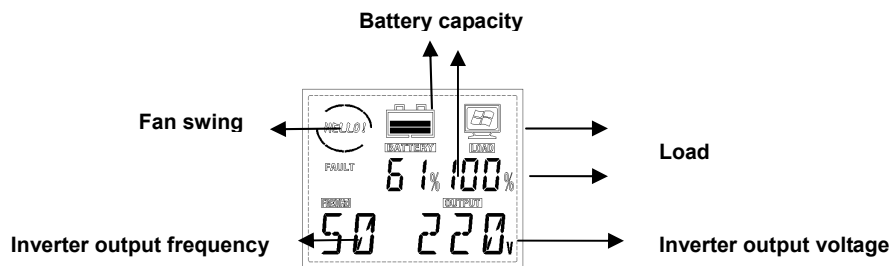

##### Mains power mode

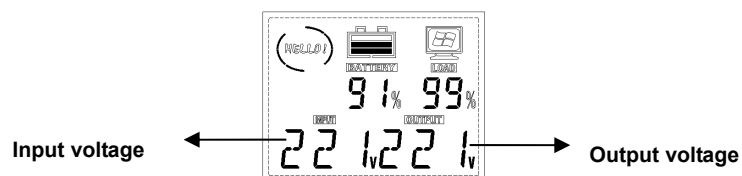



## 4.3 Settings

### 4.3.1 Setting operation

- In normal mode, press and hold “ON” + “OFF” button at the same time for 3 seconds to go to Setup mode.
- In Setup mode, press and hold “ON” + “OFF” button at the same time for 3 seconds to exit from Setup mode, and the setting are not saved.
- In Setup mode, press “ON” button for page turning to select configuration options.
- In Setup mode, press “OFF” button to configure current settings.
- In Setup mode, press “ON” button to turn to page “Save & Exit” interface, press “OFF” button and select “Y”, then press “ON” button to confirm to save datas and exsit from Setup mode.
- After the settings is configured, shut down and restart the inverter before the settings takes effect.
- In normal mode and starting state, press “OFF” button to mute.
- If there is failure and failure is solved, press “OFF” button first and release it to press “ON” button, and restart the inverter for normal use.

### 4.3.2 General settings

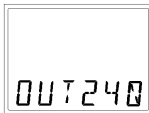
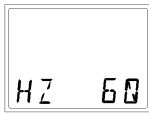
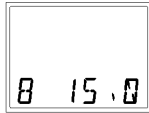
Configure these settings at any time, using the display interface.







No.	Parameters	Default Value	Options	LCD display
1	OUT: Rated output voltage of the inverter	220V	220V / 230V / 240V	
2	HZ: Rated output frequency of the inverter	50HZ	50HZ / 60HZ	
3	B: Equalizing charge voltage	14.1V	13.6V ~ 15.0V	
4	F: Floating charge voltage	13.5V	13.2V~14.6V	



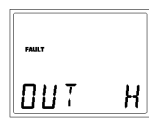

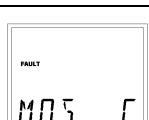
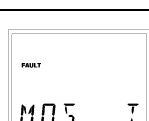

5	E: Over-discharge voltage	10.2V	9.6V ~ 11.5V	
6	CUR: Charging current	0A (300W) 20A (600W ~ 3500W)	0 ~ 60A	
7	IECO: Inverter no-load ECO mode Note: If select "Y", check whether the configured load rate in " Inverter shutdown load rate" is correct or not, if not, change it.	N	Y / N	
8	INLS: Inverter no-load shutdown function Note: If select "Y", check whether the configured load rate in " Inverter shutdown load rate" is correct or not, if not, change it.	N	Y / N	
9	DCAU: DC auto restart function Note: If select "Y", check whether the configured time in "DC auto restart time" is correct or not, if not, change it.	N	Y / N	
10	ACAU: AC self-starting function	Y	Y / N	
11	INP: Input power matching of the generator	120%	10% ~ 120% (based on rated power)	
12	INLS: Inverter shutdown load rate	3%	3% ~ 50% (based on rated power)	
13	T: DC auto restart time	1H	0.5H ~ 8.0H	
14	SAVE: Save and Exit		Y / N	

## 4.4 Troubleshooting

This section lists the status and alarm messages that the UPS might display.

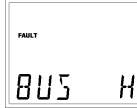
A suggested corrective action is listed with each display message to help you troubleshoot problems.

No.	Problem Description	Display Message	Corrective Action
1	AC output short circuit		Check if the load is short circuited.
2	AC output voltage is too high		Contact the dealer or supplier from whom it was purchased.
3	AC output voltage is too low		Contact the dealer or supplier from whom it was purchased.
4	Output overload		Check the load.
5	Relay fault		Contact the dealer or supplier from whom it was purchased.
6	MOSFET over-current		Contact the dealer or supplier from whom it was purchased.
7	MOS overtemperature		Decrease the operating load. Contact the dealer or supplier if the problem persists.
8	Connection of heat sink and temperature sensor abnormal		Contact the dealer or supplier from whom it was purchased.
9	Transformer overtemperature		Decrease the operating load. Contact the dealer or supplier if the problem persists.

10	Inverter AC output voltage is too high		Contact the dealer or supplier from whom it was purchased.
11	Inverter AC output voltage is too low		Contact the dealer or supplier from whom it was purchased.
12	Soft-start fault		Contact the dealer or supplier from whom it was purchased.
13	BUS voltage is too high (Battery is overcharged )		Check the battery voltage. Contact the dealer or supplier if the problem persists.
14	Charging over-current		Contact the dealer or supplier from whom it was purchased.
15	Battery voltage is too high		Check the battery voltage.
16	Battery over-discharge protection		Check the battery voltage
17	Fault self-locking		Wait for auto clearance or manually shut down and restart the inverter