

# PBE-5AC-Gen2 Quick Start Guide

## Package Contents



Dish Reflector



Antenna Feed



Rear Housing



Mounting Bracket



Hex Bolts with Washers (Qty. 4)



Pole Clamp



Carriage Bolts (Qty. 2)



Flange Nuts (Qty. 2)



Gigabit PoE (24V, 0.5A) with Mounting Bracket



Power Cord

## PBE-5AC-Gen2 Quick Start Guide

- 13 mm wrench
- Shielded Category 5 (or above) cabling with drain wire should be used for all wired Ethernet connections and should be grounded through the AC ground of the PoE. We recommend that you protect your networks from harmful outdoor environments and destructive ESD events with industrial-grade, shielded Ethernet cable from Ubiquiti. For more details, visit [ui.com/toughcable](https://ui.com/toughcable)
- Surge protection should be used for all outdoor installations. We recommend that you use two Ethernet Surge Protectors, model ETH-SP, one near the PowerBeam and the other at the entry point to the building. The ETH-SP will absorb power surges and safely discharge them into the ground.

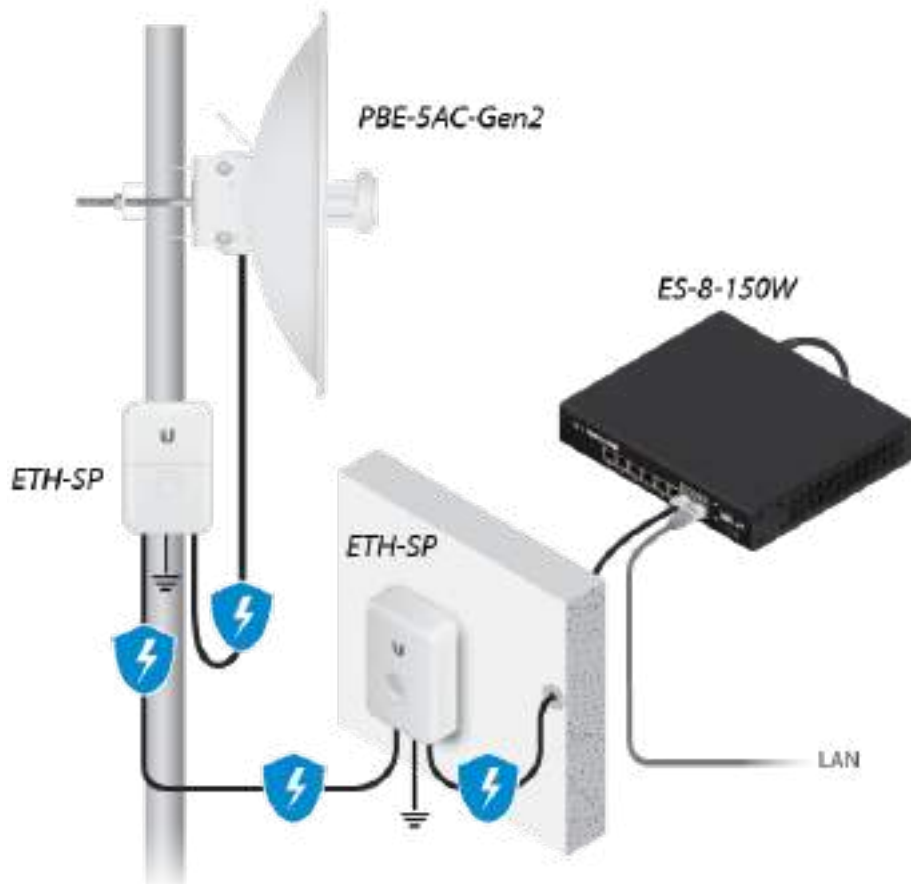

## Hardware Overview

### Bottom View

## PBE-5AC-Gen2 Quick Start Guide

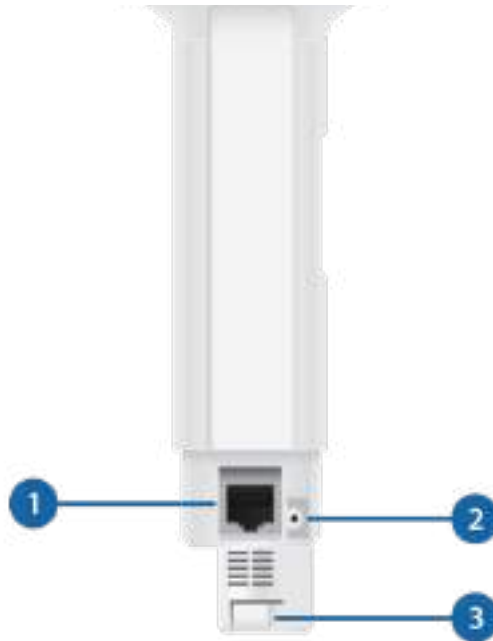
**1 Ethernet**

This Gigabit Ethernet port is used to connect the power and should be connected to the LAN and DHCP server.

**2 Reset Button**

To reset to factory defaults, press and hold the Reset button for more than 10 seconds while the device is powered on. Alternatively, the device may be reset remotely via a Reset button located on the bottom of the Gigabit PoE Adapter.

**3 Release Button**

After you assemble the PowerBeam, check the Release button; it should be fully engaged in the Release Button Slot of the Rear Housing. This ensures that the Antenna Feed is locked into place. If you need to remove the Antenna Feed, you must depress the Release button first.

## LEDs

## PBE-5AC-Gen2 Quick Start Guide



#### 4 Signal

In airOS®, you can modify the threshold value for the wireless signal strength LEDs on the Wireless tab under Signal LED Thresholds. Each LED will light when the wireless signal strength is equal to or greater than the LED's threshold value. The default threshold values for these LEDs are shown below:

*-65 dBm -73 dBm -80 dBm -94 dBm*

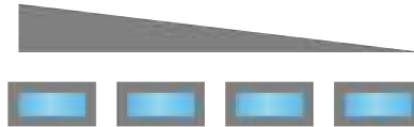

#### 5 Ethernet

The Ethernet LED will light steady blue when an active Ethernet connection is made and flash when there is activity.

#### 6 Power

The Power LED will light blue when the device is connected to a power source.

## Application Examples

The PowerBeam mounted outdoors with the Dish Reflector installed provides directional outdoor coverage (gain is reflector-dependent).

## PBE-5AC-Gen2 Quick Start Guide

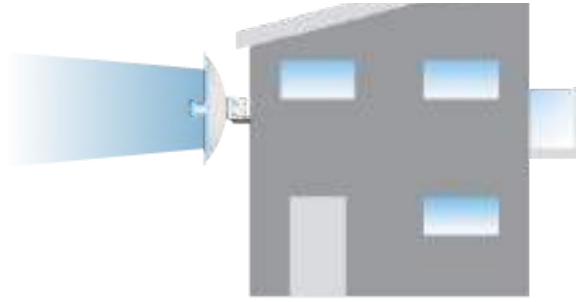

The PowerBeam mounted outdoors without the Dish Reflector installed provides outdoor-to-indoor coverage using the 3 dBi Antenna Feed only.



## Installation

1.



2.

# PBE-5AC-Gen2 Quick Start Guide



3.

## PBE-5AC-Gen2 Quick Start Guide



**Note:** In high-wind environments, you can add support with additional hardware (not included):

- a. Using the four holes in the Adjustment Bracket as a template, drill four holes into the Dish Reflector with a 4.4 mm or 1 1/64" drill bit.
- b. Secure the Dish Reflector to the Adjustment Bracket using M4 screws, washers, and nuts (not included).

4.

# PBE-5AC-Gen2 Quick Start Guide



5.





PBE-5AC-Gen2 Quick Start Guide

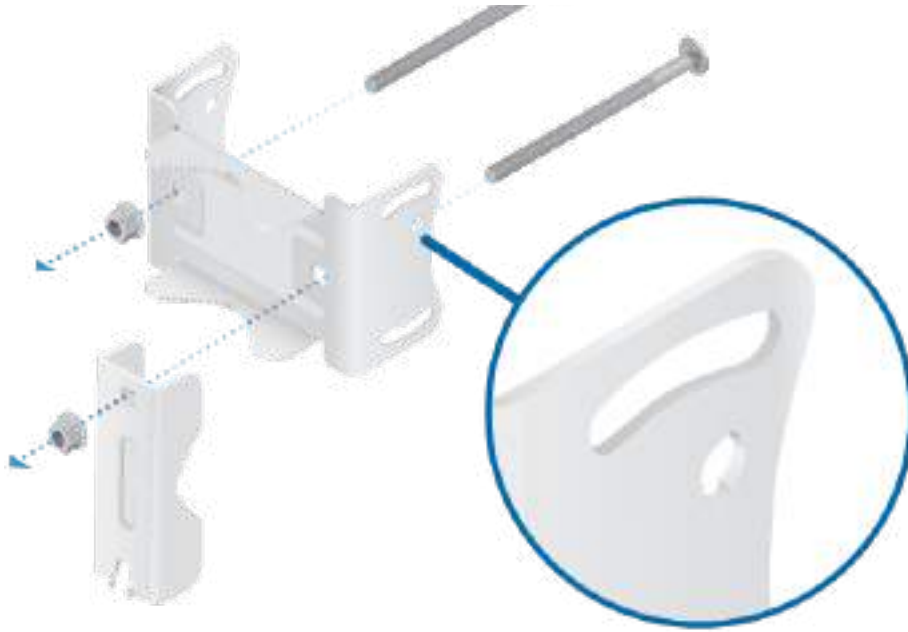

7.



8.

# PBE-5AC-Gen2 Quick Start Guide



9.

# PBE-5AC-Gen2 Quick Start Guide



10.

## PBE-5AC-Gen2 Quick Start Guide



11. Connect the power using:

- included Gigabit PoE Adapter
- PoE switch



**WARNING:** The switch port must comply with the power specifications listed in this Quick Start Guide.

## Connecting to the PoE Adapter

1. Connect the Ethernet cable from the device to the POE port of the PoE adapter.
2. Connect an Ethernet cable from your LAN to the LAN port of the PoE adapter.
3. Connect the Power Cord to the adapter, and then plug the Power Cord into a power outlet.

## PBE-5AC-Gen2 Quick Start Guide



### Mounting the PoE Adapter (Optional)

1. Remove the PoE Mounting Bracket from the adapter, place the bracket at the desired location, and mark the two holes.
2. Pre-drill the holes if necessary, and secure the bracket using two fasteners (not included).
3. Align the adapter's slots with the tabs of the PoE Mounting Bracket, and then slide the adapter down.



### Accessing airOS via Wi-Fi

Verify connectivity in the airOS® Configuration Interface using the UNMS™ app or Web Portal. Both are available for 15 minutes immediately after you power on the device. If necessary, you can power cycle the device to re-enable its Wi-Fi.

#### UNMS App

1. Download the UNMS app.



2. Connect your device's Wi-Fi to the SSID named: <model>:<MAC Address>



**Note:** Ensure that DHCP is enabled on your Wi-Fi adapter.

3. Launch the app and follow the on-screen instructions.

## PBE-5AC-Gen2 Quick Start Guide

1. Connect your device's Wi-Fi to the SSID named: <model>:<MAC Address>



**Note:** Ensure that your Wi-Fi connection has DHCP enabled.

2. Launch your web browser and go to: <http://setup.ui.com>



3. Select your Country and Language. You must agree to the Terms of Use to use the product. Click Continue.

Please Set Up Your Device

DEVICE COUNTRY  
Select Country

LANGUAGE  
English

TERMS OF USE

This Ubiquiti Inc. radio device must be professionally installed. Properly installed shielded Ethernet cable and earth grounding must be used as conditions of product warranty. It is the installer's responsibility to follow local country regulations including operation within legal frequency channels and output power requirements. You are responsible for ensuring the unit working according to these rules.

You must also read and agree to the terms of the EULA and PRIVACY POLICY before you can download or install or use the Ubiquiti airOS® Firmware.

I agree to the Ubiquiti TERMS OF USE, EULA and PRIVACY POLICY.

Continue

Have a Smartphone? Try our new UHMS to install this device

Get it on Google Play Download on the App Store

4. Create a username and password. Confirm your new password and then click Save.

## PBE-5AC-Gen2 Quick Start Guide

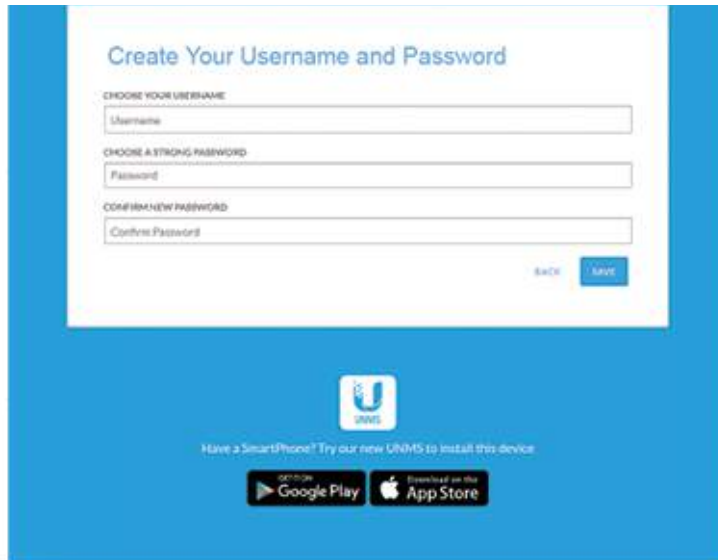

The airOS Configuration Interface will appear, allowing you to customize your settings as needed. For additional details, refer to the User Guide available at [ui.com/download/airmax-ac](http://ui.com/download/airmax-ac)

## Installer Compliance Responsibility

Devices must be professionally installed and it is the professional installer's responsibility to make sure the device is operated within local country regulatory requirements.

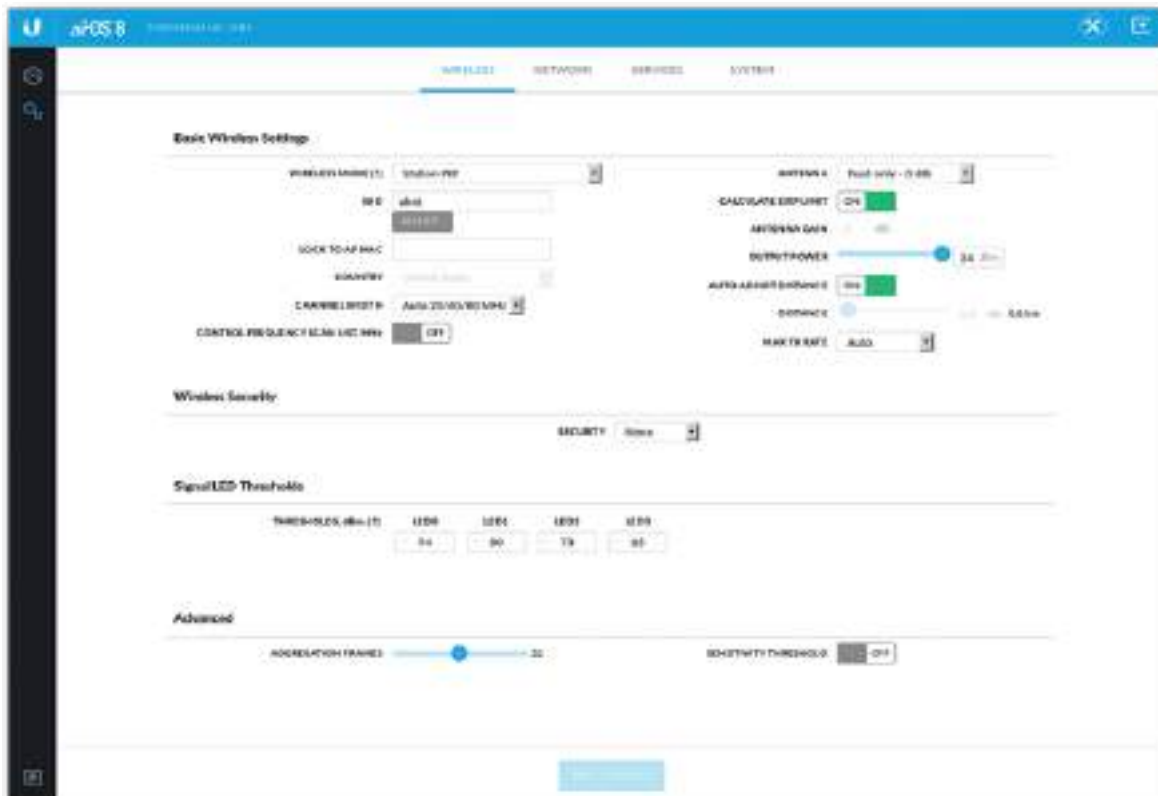

## PBE-5AC-Gen2 Quick Start Guide

Select your antenna from the list. If Calculate EIRP Limit is enabled, transmit output power is automatically adjusted to comply with the regulations of the applicable country. For a Custom antenna, Antenna Gain is entered manually. Note the requirements and antenna types listed below.

### Cable Loss (When applicable)

Enter the cable loss in dB. Output power is adjusted to compensate for loss between the radio and the antenna.

### Certified Antenna Types

This radio transmitter FCC ID: SWX-PBE5ACG2 / IC: 6545A-PBE5ACG2 has been approved by FCC / ISED Canada to operate with the antenna types listed below with the maximum permissible gain for each antenna type indicated. Antenna types not included in this list or having a gain greater than the maximum gain indicated for that type, are strictly prohibited for use with this device.

Antenna	Frequency	Gain
Dish	5 GHz	25 dBi

### Specifications

PBE-5AC-Gen2	
Dimensions	420 x 420 x 230 mm (16.54 x 16.54 x 9.06")
Weight	2.22 kg (4.89 lb)
Gain	25 dBi
Networking Interface	(1) 10/100/1000 Ethernet Port
Processor	MIPS 74Kc
Enclosure Characteristics Antenna Feed Dish Reflector	Outdoor UV Stabilized Plastic Powder-Coated SPCC
Max. Power Consumption	8.5W
Max. TX Power	24 dBm
Power Supply	24V, 0.5A Gigabit PoE Adapter (Included)
Power Method	Passive PoE (Pairs 4, 5+; 7, 8 Return)
Supported Voltage Range	20 to 26VDC
Wind Loading	380 N @ 200 km/h (85.4 lbf @ 125 mph)



## PBE-5AC-Gen2 Quick Start Guide

Mounting	Pole Mounting Kit Included
Operating Temperature	-40 to 70° C (-40 to 158° F)
Operating Humidity	5 to 95% Noncondensing
Shock and Vibrations	ETSI300-019-1.4
Certifications	CE, FCC, IC

Operating Frequency (MHz)		
Worldwide		5150 - 5875
US/CA	U-NII-1	5150 - 5250
	U-NII-2A	5250 - 5350
	U-NII-2C	5470 - 5725
	U-NII-3	5725 - 5850

Management Radio (MHz)	
Worldwide	2412 - 2472
US/CA	2412 - 2462

## Safety Notices

1. Read, follow, and keep these instructions.
2. Heed all warnings.
3. Only use attachments/accessories specified by the manufacturer.



**WARNING:** Do not use this product in location that can be submerged by water.



**WARNING:** Avoid using this product during an electrical storm. There may be a remote risk of electric shock from lightning.

## Electrical Safety Information

1. Compliance is required with respect to voltage, frequency, and current requirements indicated on the manufacturer's label. Connection to a different power source than those specified may result in improper operation, damage to the equipment or pose a fire hazard if the limitations are not followed.
2. There are no operator serviceable parts inside this equipment. Service should be provided only by a qualified service technician.
3. This equipment is provided with a detachable power cord which has an integral safety ground wire intended for connection to a grounded safety outlet.

## PBE-5AC-Gen2 Quick Start Guide

grounding wire.

- b. The equipment requires the use of the ground wire as a part of the safety certification, modification or misuse can provide a shock hazard that can result in serious injury or death.
- c. Contact a qualified electrician or the manufacturer if there are questions about the installation prior to connecting the equipment.
- d. Protective earthing is provided by Listed AC adapter. Building installation shall provide appropriate short-circuit backup protection.
- e. Protective bonding must be installed in accordance with local national wiring rules and regulations.

## Limited Warranty

[ui.com/support/warranty](http://ui.com/support/warranty)

The limited warranty requires the use of arbitration to resolve disputes on an individual basis, and, where applicable, specify arbitration instead of jury trials or class actions.

## Compliance

### FCC

Changes or modifications not expressly approved by the party responsible for compliance could void the user's authority to operate the equipment.

This device complies with Part 15 of the FCC Rules. Operation is subject to the following two conditions.

1. This device may not cause harmful interference, and
2. This device must accept any interference received, including interference that may cause undesired operation.

This equipment has been tested and found to comply with the limits for a Class A digital device, pursuant to part 15 of the FCC Rules. These limits are designed to provide reasonable protection against harmful interference when the equipment is operated in a commercial environment. This equipment generates, uses, and can radiate radio frequency energy and, if not installed and used in accordance with the instruction manual, may cause harmful interference to radio communications. Operations of this equipment in a residential area is likely to cause harmful interference in which case the user will be required to correct the interference at his own expense.

This radio transmitter has been approved by FCC.

### ISED Canada

#### CAN ICES-3(A)/NMB-3(A)

This device complies with ISED Canada licence-exempt RSS standard(s). Operation is subject to the following two conditions:

1. This device may not cause interference, and
2. This device must accept any interference, including interference that may cause undesired operation of the device.

This radio transmitter has been approved by ISED Canada.

## PBE-5AC-Gen2 Quick Start Guide

### CAN ICES-3(A)/NMB-3(A)

Le présent appareil est conforme aux CNR d'ISDE Canada applicables aux appareils radio exempts de licence. L'exploitation est autorisée aux deux conditions suivantes :

1. l'appareil ne doit pas produire de brouillage;
2. l'appareil doit accepter tout brouillage radioélectrique subi, même si le brouillage est susceptible d'en compromettre le fonctionnement.

Le présent émetteur radio a été approuvé par ISDE Canada.

Les dispositifs fonctionnant dans la bande 5150-5250 MHz sont réservés uniquement pour une utilisation à l'intérieur afin de réduire les risques de brouillage préjudiciable aux systèmes de satellites mobiles utilisant les mêmes canaux.

### IMPORTANT NOTE

#### Radiation Exposure Statement

- This equipment complies with radiation exposure limits set forth for an uncontrolled environment.
- This equipment should be installed and operated with minimum distance 137 cm between the radiator and your body.
- This transmitter must not be co-located or operating in conjunction with any other antenna or transmitter.

### AVIS IMPORTANT

#### Déclaration sur l'exposition aux rayonnements

- Cet équipement est conforme aux limites prévues pour l'exposition aux rayonnements dans un environnement non contrôlé.
- Lors de l'installation et de la mise en fonctionnement de l'équipement, assurez-vous qu'il y ait une distance minimale de 137 cm entre l'élément rayonnant et vous.
- Cet émetteur ne doit être installé à proximité d'aucune autre antenne ni d'aucun autre émetteur, et ne doit être utilisé conjointement à aucun autre de ces appareils.

### Australia and New Zealand



Warning: This equipment is compliant with Class A of CISPR 32. In a residential environment this equipment may cause radio interference.

### Brazil



**Nota:** Este equipamento não tem direito à proteção contra interferência prejudicial e não pode causar interferência em sistemas devidamente autorizados.

### CE Marking

## PBE-5AC-Gen2 Quick Start Guide



### Country List



AT	BE	BG	CY	CZ	DE	DK	EE	EL	ES	FI	FR	HR	HU
IE	IT	LV	LT	LU	MT	NL	PL	PT	RO	SE	SI	SK	UK

BFWA (Broadband Fixed Wireless Access) members noted in blue



**Note:** This device meets Max. TX power limit per ETSI regulations.

The following apply to products that operate in the 5 GHz frequency range:



**Note:** This device is restricted to indoor use only when operating in the 5150 - 5350 MHz frequency range within all member states.



**Note:** All countries listed may operate at 30 dBm. BFWA member states may operate at 36 dBm.



**Note:** Operation in the 5.8 GHz frequency band is prohibited in BFWA member states. Other countries listed may use the 5.8 GHz frequency band.

## WEEE Compliance Statement

## Declaration of Conformity

## Online Resources





# PBE-5AC-Gen2 Quick Start Guide

© 2020 Ubiquiti Inc. All rights reserved.