

# Yealink

## Ceiling Microphone

VCM38

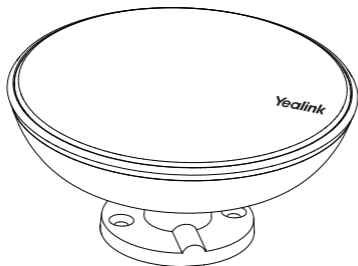

English | 简体中文

### Quick Start Guide(V1.0)

[www.yealink.com](http://www.yealink.com)

# Package Contents



VCM38



Telescopic rod



Expansion screws  
and Self-tapping screws



Quick Start Guide

## Connecting Your VCM38

Choose one of the following ways to connect your VCM38 to the video conference system/UVC series camera:

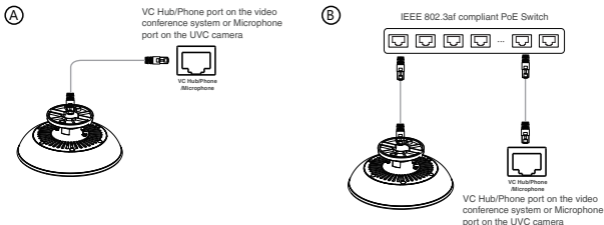

Note: Up to 8 VCM38s can be used in one video conferencing system.

## Installing Your VCM38

### Mounting height suggestion

The recommended installation height of the microphone is 2.5 meters from the ground (can be adjusted according to the actual situation).

The best pickup distance of VCM38 is shown as below:

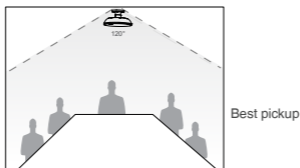

Note: We recommend that the VCM38 be installed away from air conditioning or air vents and other obvious sources of noise.

## Suspend on the ceiling/suspended ceiling

The VCM38 can be suspended on the ceiling directly when the height of the ceiling/suspended ceiling for VCM38 installation meets the best pickup range.



1

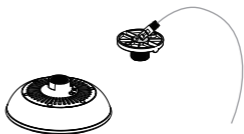

2

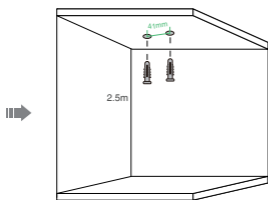

3

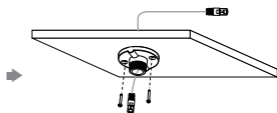

4

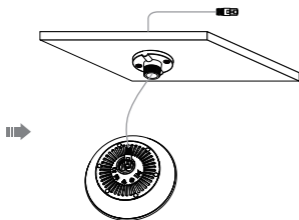

5

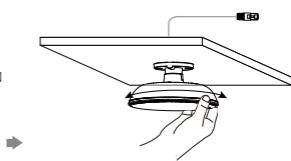

6

## Hang on the ceiling/suspended ceiling

The VCM38 can be hung on the ceiling when the height of the ceiling/suspended ceiling for VCM38 installation is beyond the best pickup range.

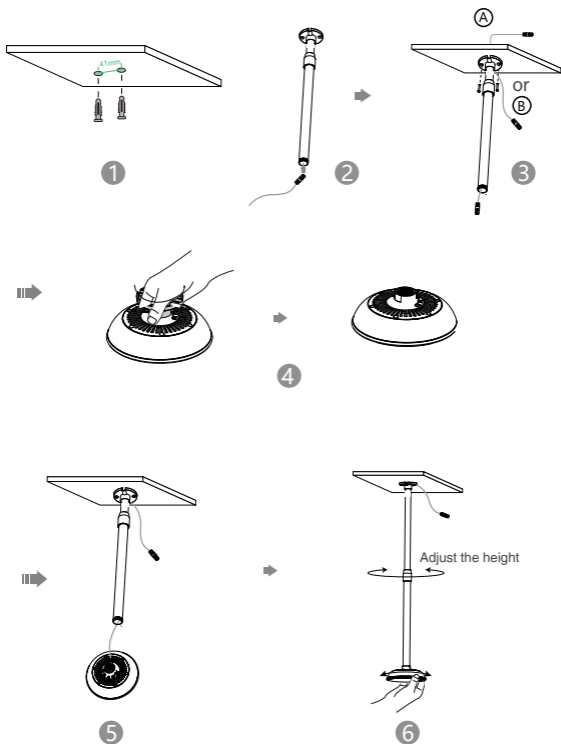

# 包装清单



VCM38



吊杆



膨胀螺丝和自攻螺丝



快速入门指南

## 连接VCM38

选择以下任意一种连接方式将VCM38连接到会议电视终端或UVC系列摄像机：

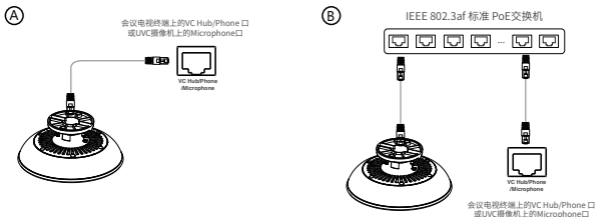

说明：在一个视频会议系统中最多可同时使用8个VCM38。

## 安装VCM38

### VCM38安装高度适配

麦克风建议安装高度为距离地面2.5米（可根据会场实际情况进行调整）。  
VCM38最佳拾音距离如下图：

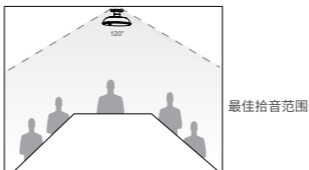

说明：建议安装时远离空调或换气通风口以及远离其他明显的噪声来源。

## 吸顶安装

天花板/吊顶高度适配VCM38安装的最佳拾音距离时,可以使用吸顶安装。



1

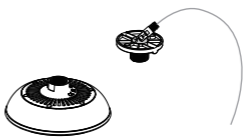

2

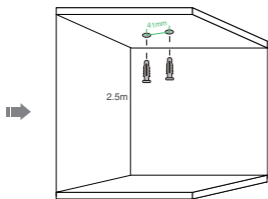

3

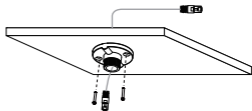

4

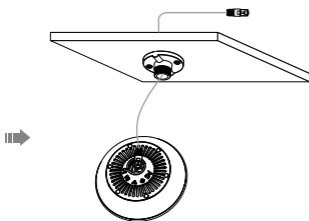

5

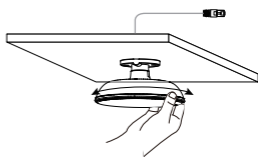

6

## 悬挂安装

天花板/吊顶高度在超出VCM38可以直接安装的最佳拾音范围时,可以使用吊杆将VCM38悬挂在天花板/吊顶上。

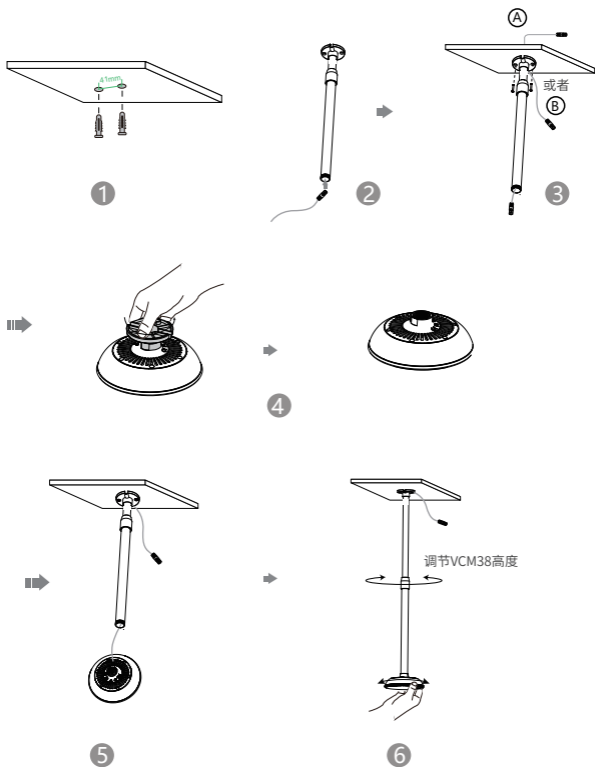

## Regulatory Notices

### Operating Ambient Temperatures

- Operating temperature: +32 to 104°F (0 to +40°C)
- Relative humidity: 5% to 90%, noncondensing
- Storage temperature: -22 to +160°F (-30 to +70°C)

### Warranty

Our product warranty is limited only to the unit itself, when used normally in accordance with the operating instructions and the system environment. We are not liable for damage or loss resulting from the use of this product, or for any claim from a third party. We are not liable for problems with Yealink device arising from the use of this product, we are not liable for financial damages, lost profits, claims from third parties, etc., arising from the use of this product.

### Explanation of the symbols

#### ● DC symbol

— is the DC voltage symbol.

#### ● WEEE Warning symbol

To avoid the potential effects on the environment and human health as a result of the presence of hazardous substances in electrical and electronic equipment, end users of electrical and electronic equipment should understand the meaning of the crossed-out wheeled bin symbol. Do not dispose of WEEE as unsorted municipal waste and have to collect such WEEE separately.

### Restriction of Hazardous Substances Directive (RoHS)

This device complies with the requirements of the EU RoHS Directive. Statements of compliance can be obtained by contacting support@yealink.com.

### Safety Instructions

Save these instructions. Read these safety instructions before use!

#### △ General Requirements

- Before you install and use the device, read the safety instructions carefully and observe the situation during operation.
- During the process of storage, transportation, and operation, please always keep the device dry and clean, avoid collision and crash.
- Please attempt not to dismantle the device by yourself. In case of any discrepancy, please contact the appointed maintenance center for repair.
- Please refer to the relevant laws and statutes while using the device. Legal rights of others should be respected as well.

#### △ Environmental Requirements

- Place the device at a well-ventilated place. Do not expose the device under direct sunlight.
- Keep the device dry and free of dusts.
- Do not place the device on or near any inflammable or fire-vulnerable object, such as rubber-made materials.
- Keep the device away from any heat source or bare fire, such as a candle or an electric heater.

#### △ Operating Requirements

- Do not let a child operate the device without guidance.
- Do not let a child play with the device or any accessory in case of accidental swallowing.
- Please use the accessories provided or authorized by the manufacturer only.
- The power supply of the device shall meet the requirements of the input voltage of the device. Please use the provided surge protection power socket only.
- Before plugging or unplugging any cable, make sure that your hands are completely dry.
- Do not spill liquid of any kind on the product or use the equipment near water, for example, near a bathtub, washbowl, kitchen sink, wet basement or near a swimming pool.
- During a thunderstorm, stop using the device and disconnect it from the power supply. Unplug the power plug and the Asymmetric Digital Subscriber Line (ADSL) twisted pair (the radio frequency cable) to avoid lightning strike.

## About Yealink

Yealink is a global leading provider of enterprise communication and collaboration solutions, offering video conferencing service to worldwide enterprises. Focusing on research and development, Yealink also insists on innovation and creation. With the outstanding technical patents of cloud computing, audio, video and image processing technology, Yealink has built up a panoramic collaboration solution of audio and video conferencing by merging its cloud services with a series of endpoints products. As one of the best providers in more than 140 countries and regions including the US, the UK and Australia, Yealink ranks No.1 in the global market share of SIP phones shipments.

### Technical Support

Visit Yealink WIKI (<http://support.yealink.com/>) for the latest firmware, guides, FAQ, Product documents, and more. For better service, we sincerely recommend you to use Yealink Ticketing system (<https://ticket.yealink.com/>) to submit all your technical issues.



430104001303

- If the device is left unused for a rather long time, disconnect it from the power supply and unplug the power plug.
- When there is smoke emitted from the device, or some abnormal noise or smell, disconnect the device from the power supply, and unplug the power plug immediately.
- Contact the specified maintenance center for repair.
- Do not insert any object into equipment slots that is not part of the product or auxiliary product.
- Before connecting a cable, connect the grounding cable of the device first. Do not disconnect the grounding cable until you disconnect all other cables.

#### △ Cleaning Requirements

- Before cleaning the device, disconnect it from the power supply.
- Use a piece of soft, dry and anti-static cloth to clean the device.
- Keep the power plug clean and dry.

#### Troubleshooting

The unit cannot supply power to device other than Yealink device. There is a bad connection with the plug.

1. Clean the plug with a dry cloth.
  2. Connect it to another wall outlet.
- The usage environment is out of operating temperature range.
1. Use in the operating temperature range.
- The cable between the unit and the Yealink device is connected incorrectly.
1. Connect the cable correctly.
  1. You cannot connect the cable properly.
  1. You may have connected a wrong Yealink device.
  2. Use the correct power supply.
- Some dust, etc., may be in the port.
1. Clean the port.
- Contact your dealer or authorized service facility for any further questions.

#### FCC Statement

This device complies with part 15 of the FCC Rules. Operation is subject to the following two conditions: (1) this device may not cause harmful interference, and (2) this device must accept any interference received, including interference that may cause undesired operation.

Any Changes or modifications not expressly approved by the party responsible for compliance could void the user's authority to operate the equipment.

#### IC Statement

This device complies with Industry Canada's licence-exempt RSSs. Operation is subject to the following two conditions:

- (1) this device may not cause interference; and
- (2) this device must accept any interference, including interference that may cause undesired operation of the device. CAN ICES-3(B)

Le présent appareil est conforme aux CNR d'Industrie Canada applicables aux appareils radio exempts de licence. L'exploitation est autorisée aux deux conditions suivantes :

- (1) l'appareil ne doit pas produire de brouillage;
- (2) l'utilisateur de l'appareil doit accepter tout brouillage radioélectrique subi, même si le brouillage est susceptible d'en compromettre le fonctionnement. NMB-3(B)

#### Radiation Exposure Statement

This equipment complies with FCC and IC radiation exposure limits set forth for an uncontrolled environment. This equipment should be installed and operated with minimum distance 20cm between the radiator and your body.

Cet émetteur ne doit pas être Co-placé ou ne fonctionner en même temps qu'aucune autre antenne ou émetteur. Cet équipement devrait être installé et actionné avec une distance minimum de 20 centimètres entre le radiateur et votre corps.

#### Contact Information

YEALINK NETWORK TECHNOLOGY CO., LTD.  
309, 3rd Floor, No.16, Yun Ding North Road, Huli District, Xiamen City, Fujian, P.R.C  
YEALINK (EUROPE) NETWORK TECHNOLOGY B.V.  
Stawinskiyaan 3127, Atrium Building, 8th floor, 1077ZX Amsterdam, The Netherlands  
YEALINK (USA) NETWORK TECHNOLOGY CO., LTD.  
999 Peachtree Street Suite 2300, Fulton, Atlanta, GA, 30309, USA  
Made in China



YEALINK(XIAMEN) NETWORK TECHNOLOGY CO.,LTD.

Web: [www.yealink.com](http://www.yealink.com)

Copyright©2020YEALINK(XIAMEN) NETWORK

TECHNOLOGY CO.,LTD.All rights reserved.