



E230C Series LED Monitor

User's Manual



Foreword

General





This manual introduces the installation, functions and operations of the E230C Series LED Monitor Devices (hereinafter referred to as the "Devices"). Read carefully before using the device, and keep the manual safe for future reference.

Models

DHI-LM24-E230C, DHI-LM27-E230C, DHI-LM32-E230C.

Safety Instructions

The following signal words might appear in the manual.

Signal Words	Meaning
 DANGER	Indicates a high potential hazard which, if not avoided, will result in death or serious injury.
 WARNING	Indicates a medium or low potential hazard which, if not avoided, could result in slight or moderate injury.
 CAUTION	Indicates a potential risk which, if not avoided, could result in property damage, data loss, reductions in performance, or unpredictable results.
 TIPS	Provides methods to help you solve a problem or save time.
 NOTE	Provides additional information as a supplement to the text.

Revision History

Version	Revision Content	Release Time
V1.0.0	First release.	March 2023

Privacy Protection Notice

As the device user or data controller, you might collect the personal data of others such as their face, fingerprints, and license plate number. You need to be in compliance with your local privacy protection laws and regulations to protect the legitimate rights and interests of other people by implementing measures which include but are not limited: Providing clear and visible identification to inform people of the existence of the surveillance area and provide required contact information.

About the Manual

- The manual is for reference only. Slight differences might be found between the manual and the product.
- We are not liable for losses incurred due to operating the product in ways that are not in compliance with the manual.
- The manual will be updated according to the latest laws and regulations of related jurisdictions. For detailed information, see the paper user's manual, use our CD-ROM, scan the QR code or visit our official website. The manual is for reference only. Slight differences might be found between the electronic version and the paper version.
- All designs and software are subject to change without prior written notice. Product updates might result in some differences appearing between the actual product and the manual. Please contact customer service for the latest program and supplementary documentation.
- There might be errors in the print or deviations in the description of the functions, operations and technical data. If there is any doubt or dispute, we reserve the right of final explanation.
- Upgrade the reader software or try other mainstream reader software if the manual (in PDF format) cannot be opened.
- All trademarks, registered trademarks and company names in the manual are properties of their respective owners.
- Please visit our website, contact the supplier or customer service if any problems occur while using the device.
- If there is any uncertainty or controversy, we reserve the right of final explanation.

Important Safeguards and Warnings

This section introduces content covering the proper handling of the device, hazard prevention, and prevention of property damage. Read carefully before using the device, and comply with the guidelines when using it.

Operation Requirements

WARNING

- Do not tread on or squeeze the power line, especially the plug or connection point of the power line to the product.
- Please firmly grasp the plug of the connecting line when inserting and removing. Pulling the connecting line might cause damage to it.
- Turn off the power when cleaning the product.
- Do not touch any fixed components inside the product. Failure to do so can result in damage to the product or person.



- Make sure that the power supply of the device works properly before use.
- Do not pull out the power cable of the device while it is powered on.
- Only use the device within the rated power range.
- Transport, use and store the device under allowed humidity and temperature conditions.
- Prevent liquids from splashing or dripping on the device. Make sure that there are no objects filled with liquid on top of the device to avoid liquids flowing into it.
- Do not disassemble the device.
- Notice and observe all the warnings and illustrations.
- Make sure the power is turned off and the connecting lines are removed when moving the product.
- Do not use uncertified connecting lines, which might cause equipment failure.
- Avoid collisions with the product. This may cause equipment failure.
- Please turn off power for safety if not using the product for a long time.

Installation Requirements

WARNING

- Connect the device to the adapter before power on.
- Strictly abide by local electrical safety standards, and make sure that the voltage in the area is steady and conforms to the power requirements of the device.
- Do not connect the device to more than one power supply. Otherwise, the device might become damaged.
- Do not hang or lean on the product. Doing so can cause the product to fall or become damaged. It may also cause injury to people. Pay special attention when children are nearby.

- If the product is installed on the wall, please make sure the wall's load bearing capacity is sufficient. To avoid falling and injuring people, install according to the included instructions with mounting hardware.
- Do not put the product in flammable or corrosive gaseous environment, which may cause fire or damage the product. Placing the product in proximity to flammable gas can easily result in a dangerous explosion.



- Observe all safety procedures and wear required protective equipment provided for your use while working at heights.
- Do not expose the device to direct sunlight or heat sources.
- Do not install the device in humid, dusty or smoky places.
- Install the device in a well-ventilated place, and do not block the ventilator of the device.
- Use the power adapter or case power supply provided by the device manufacturer.
- The power supply must conform to the requirements of ES1 in IEC 62368-1 standard and be no higher than PS2. Note that the power supply requirements are subject to the device label.
- Connect class I electrical appliances to a power socket with protective earthing.
- Do not block the ventilation opening. Install the product according to this handbook.
- Do not place any items on the product. The product may be damaged if foreign objects enter the internal unit.
- Failure to properly secure all screws during installation can result in a fall of the product. Ensure all mounting hardware and other installation accessories are properly secured during installation.
- Mounted height <2m.
-  Protective earthing terminal. The apparatus should be connected to a mains socket outlet with a protective earthing connection.
- ~Alternating Current.

Maintenance Requirements



WARNING

- Cut off power and the connecting line immediately and contact the after-sales service center if the product or the connecting line is damaged for some reason. Continued use without maintenance might cause smoking or off-odor.
- Please turn off power or unplug the power cable immediately if there is smoking, off-odor, or abnormal noise. Contact the after-sales service center for maintenance after confirming there is no more smoke or odor. Further use could result in fire.



- Do not adjust, maintain or modify if you do not have appropriate qualifications.
- Do not open or remove the rear cover, box or cover board of the product. Please contact the dealer or after-sales service center when in need of adjustment or maintenance.
- Only qualified service people can maintain. If the product gets any kind of damage, such as damage to the plug, foreign matter or liquid into the unit, exposure to rain or humidity, loss of function, or dropped, please contact dealer or after-sales service center.

- Be careful during maintenance of product even if the power is off. Some components are equipped with UPS, and can continue to supply power which is dangerous to people.

Table of Contents

Foreword	I
Important Safeguards and Warnings	III
1 Packing List	1
1.1 DHI-LM24-E230C/DHI-LM27-E230C	1
1.2 DHI-LM32-E230C	1
2 Monitor Adjustments	2
3 Button Description	3
3.1 DHI-LM24-E230C/DHI-LM27-E230C	3
3.2 DHI-LM32-E230C	3
4 Cable Connection	5
4.1 DHI-LM24-E230C / DHI-LM27-E230C	5
4.2 DHI-LM32-E230C	6
5 Menu Description	7
6 Lighting effect control and Game Crosshair	9
7 Operation Menu(OSD) Function Descriptions	10
8 Product Specifications	12
Appendix 1 Troubleshooting	13
Appendix 2 Cybersecurity Recommendations	14

1 Packing List

1.1 DHI-LM24-E230C/DHI-LM27-E230C

Table 1-1 Packing list

Name	Quantity	Name	Quantity
Display screen	1	Screws	3
Base/Stand	1	Harness seat	1
Power adapter	1	Rubber foot	1
DP signal cable	1	QSG	1
Mount stud	4	Regulations folding	1



The above appendix products are for reference only, the supporting products of different models of monitors may be slightly different from those in the figure, and everything is subject to reality.

1.2 DHI-LM32-E230C

Table 1-2 Packing list description

Name	Quantity	Name	Quantity
Display screen	1	PM4*12 Screw bolts	4
Base/Stand	2	KM4*12 Screw bolts	3
Power adapter	3	PM4*16 Screw bolts	4
DP signal cable	4	QSG	1
VESA connector	5	Regulations folding	1



The above appendix products are for reference only, the supporting products of different models of monitors may be slightly different from those in the figure, and everything is subject to reality.

2 Monitor Adjustments

Some displays can be angled by tilting forward and backward, and typically, it can tilt $5\pm 2^\circ$ forward and $15\pm 2^\circ$ backwards. The specific adjustment function is subject to the adjustment function of the actual model.

Figure 2-1 Monitor adjustments

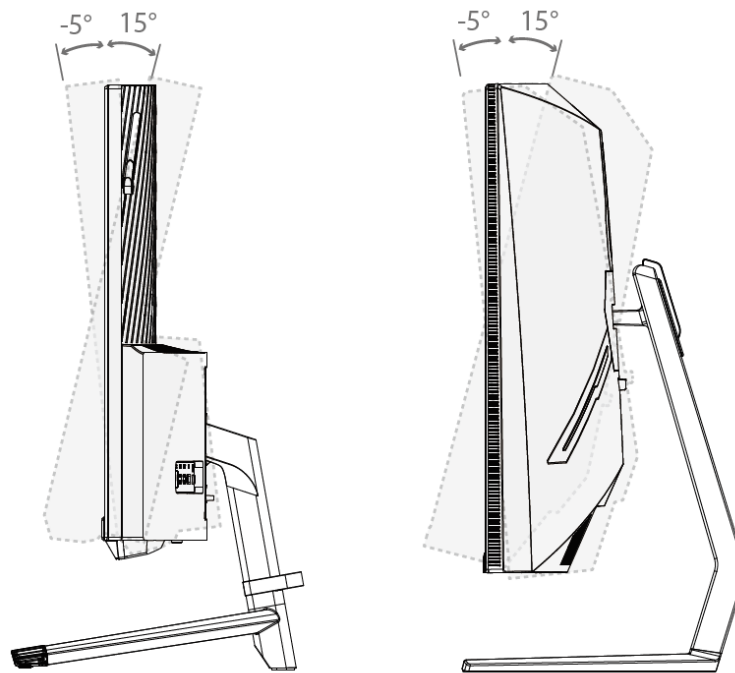

- Tilting angle: $-5.0^\circ(\pm 2.0^\circ)$ - $+15^\circ(\pm 2.0^\circ)$.
- When adjusting the angle of the monitor, be sure not to touch or press the area of the screen. The above figure is for reference only, and everything is subject to the actual adjustment function.

3 Button Description

3.1 DHI-LM24-E230C/DHI-LM27-E230C

Figure 3-1 Indicator and button display

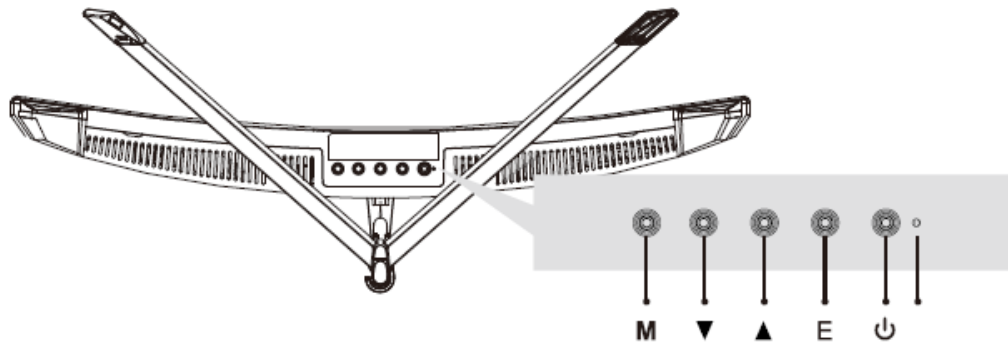

Table 3-1 Indicator and button description

Name& Button	Description
LED indicator light	<ul style="list-style-type: none"> The blue light indicates that the power supply is normal and the monitor is running normally. Red light indicates no video source, no horizontal or vertical signal or low voltage is detected. The light is off when the screen is turned off.
M	Menu button: Press to display OSD menu and enter sub-menus.
▼	Down button: Move down in the menu/quickly adjust the game crosshairs.
▲	Up button: Move up/quickly adjust Lighting effects control
E	Exit key: Returns to the previous menu
⏻	Power button: Press to turn monitor on/off



The above content is for reference only, and everything is subject to actual conditions.

3.2 DHI-LM32-E230C

Figure 3-2 Indicator and button display

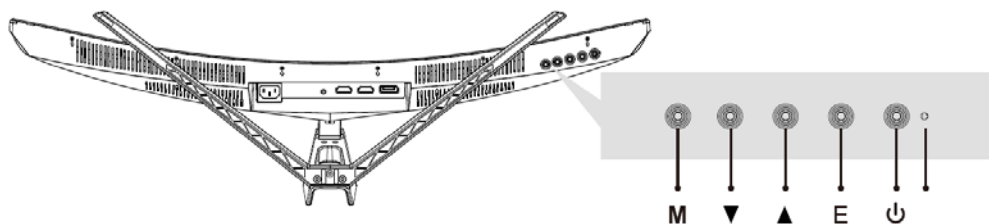

Table 3-2 Indicator and button description

Name& Button	Description
LED indicator light	<ul style="list-style-type: none"> ● The blue light indicates that the power supply is normal and the monitor is running normally. ● Flashing blue light indicates no video source, no horizontal or vertical signal or too low a voltage. ● The light is off when the screen is turned off.
M	Menu button: Press to display OSD menu and enter sub-menus.
▼	Down button: Move down in the menu/quickly adjust the game crosshairs.
▲	Up button: Move up/quickly adjust Lighting effects control.
E	Exit key: Returns to the previous menu.
⏻	Power button: Press to turn monitor on/off.



The above content is for reference only, and everything is subject to actual conditions.

4 Cable Connection

4.1 DHI-LM24-E230C / DHI-LM27-E230C

Figure 4-1 Input and output interface

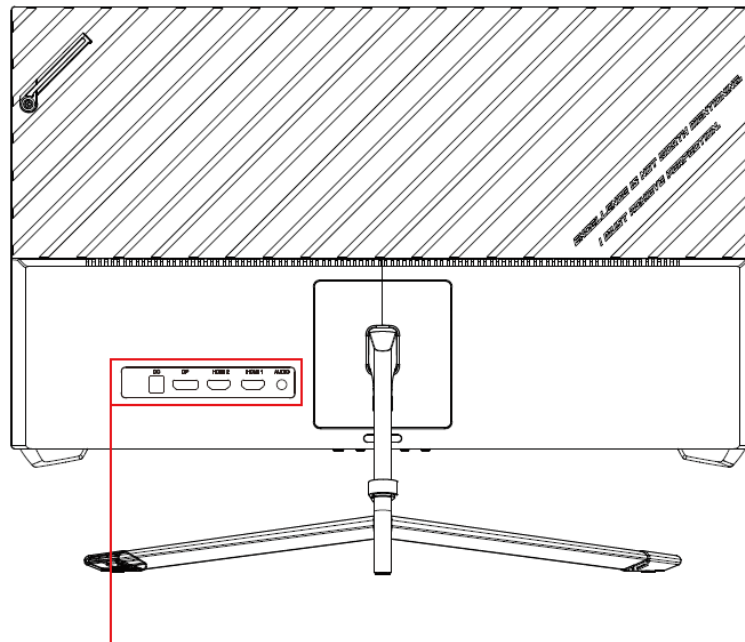

Input and output ports

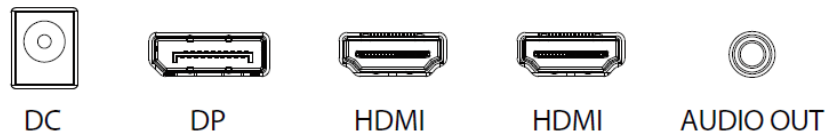

Figure 4-2 Input and output ports

OSD Button	Description
DC	x1/ Used to connect power adopters
DP	x1/ Use the DP cable to connect to a desktop PC
HDMI	x2/ Use the HDMI cable to connect the HDMI IN interface of the product to the HDMI OUT interface of a PC.
AUDIO OUT	x1/ Use to connect with external sound output devices such as headphones or earphones.



The above content is for reference only, and everything is subject to actual conditions.

4.2 DHI-LM32-E230C

Figure 4-3 Input and output interface

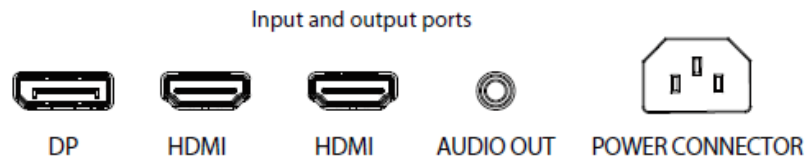
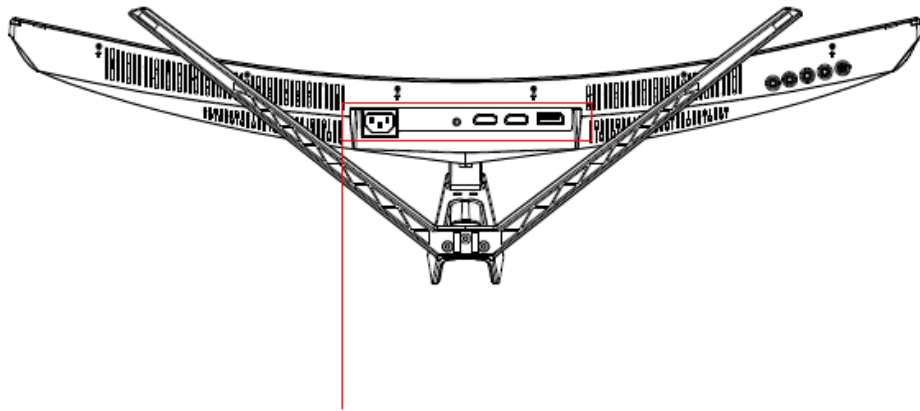

Figure 4-4 Input and output ports

OSD Button	Description
DP	x1/ Use the DP cable to connect to a desktop PC.
HDMI	x2/ Use the HDMI cable to connect the HDMI IN interface of the product to the HDMI OUT interface of a PC.
AUDIO OUT	x1/ Use to connect with external sound output devices such as headphones or earphones.
POWER CONNECTOR	x1/ Insert the power cable to supply power to the monitor.



The above ports are for reference only, the actual ports of different types of monitors may be slightly different from the ports in the figure, and everything is subject to the ports and functions of the actual product.

5 Menu Description

- The color and shape of the OSD menu of the actual computer may be slightly different from that shown in the figure, and everything that has been actually displayed shall prevail.
- Specifications of the OSD menu may change with improvements of functions without prior notice.





The on-screen display (OSD) menu can be used to adjust the settings of the monitor and is displayed on the screen after turning on the monitor and pressing the  button.

Step 1 Press one of the buttons to activate the Navigation window.

Figure 5-1 Navigation window



Table 5-1 Icon function

Icon	Function
	Confirm and enter the main menu
	Game Crosshair
	Lighting effect control
	Exit the menu interface
	Power switch







Step 2 Press  to enter the OSD screen.

Figure 5-2 OSD screen



Step 3 Press  or  to browse through the functions.

- Select the desired function, then press the  button to enter the submenu.

- Press ▼ or ▲ to browse the sub-menus, and then press  the key to confirm the selection of the desired function.
- Press ▼ or ▲ to select an option, then press  to confirm the setting and exit the current menu.

Step 4 Press  to exit the menu interface.

6 Lighting effect control and Game Crosshair

Step 1 Press any one of the buttons (M, ▼, ▲, E) to activate the navigation window.

Figure 6-1 Navigation window



Step 2 Press ▲ (🖱️) button to quickly switch between light effect control modes and choose the light effect mode that best suits you.

Figure 6-2 Lighting effect control

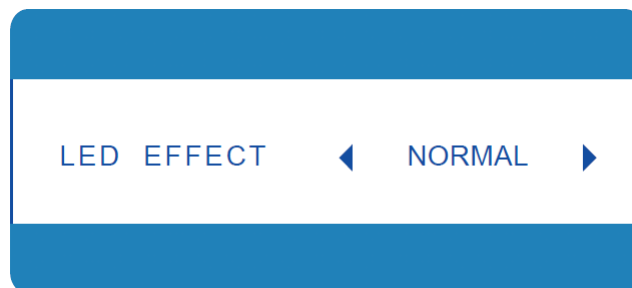

Step 3 Press ▼ (🎯) button to switch Gameplus modes. Choose the crosshair icon best suited for your game. These game icons are primarily designed to optimize your aim during shooting games, though they can be used for other scenarios.

Figure 6-3 Game Crosshair



7 Operation Menu(OSD) Function Descriptions

Figure 7-1 OSD menu description

Menu	Sub Menu	Value Range
BRIGHTNESS	BRIGHTNESS	0-100
	CONTRAST	0-100
	ECO	STANDARD/GAME/RTS/FPS/MOVIE/TEXT
	DCR	ON/OFF
IMAGE	H. POSITION	0-100
	V.POSITION	0-100
	CLOCK	0-100
	PHASE	0-100
	ASPECT	WIDE/AUTO/4:3
COLOR TEMP.	COLOR TEMP.	WARM/COOL/USER
	RED	0-100
	GREEN	0-100
	BLUE	0-100
OSD SETTING	LANGUAGE	ENGLISH /FRANÇAIS /DEUTSCH /简体中文/ITALIANO /ESPAÑOL/PORTUGUÊS TURKCE /POLSKI /NEDERLANDS /РУССКИЙ /한국/日本語
	OSD H. POS.	0-100
	OSD V. POS.	0-100
	OSD TIMER	5-60
	TRANSPAREN CY	0-100
RESET	IMAGE AUTO ADJUST	-
	COLOR AUTO ADJUST	-
	RESET	-
	MPRT	OFF/ON
MISC	SIGNAL SOURCE	DP/HDMI1/HDMI2
	VOLUME	0-100
	LOW BLUE RAY	0-100
	ADAPTIVE- SYNC	ON/OFF
	OVER DRIVER	OFF/HIGH/MIDDLE/LOW
	LED EFFECT	NORMAL/OFF/FLICKER



The OSD features in the table above are for reference only and may differ from the actual display, so the OSD features of the actual display shall prevail.

8 Product Specifications

Table 8-1 Product Specifications

Product Model		DHI-LM24-E230C	DHI-LM27-E230C	DHI-LM32-E230C
Screen Size		23.6"	27"	31.5"
Aspect Ratio		16:9	16:9	16:9
Viewing Angle		178°(H) / 178°(V)	178°(H) / 178°(V)	178°(H) / 178°(V)
Contrast Ratio		3000:1 (TYP)	4000:1 (TYP)	3000:1 (TYP)
Colors		16.7M	16.7M	16.7M
Resolution		1920x1080	1920x1080	1920x1080
Maximum refresh rate		165Hz	165Hz	165Hz
Product Dimensions Lifting base	Without base	537.9 x 333.5 x 74 mm	613 x 365.2 x 81.6 mm	712.6 x 422.8 x 120.6mm
	With base	537.9 x 410.1 x 200.4 mm	613 x 455.4 x 200.4 mm	712.6 x 508.5 x 245.1mm
Speaker		No	No	No
Height Range		No	No	No
Rotation Angle		No	No	No
Vertical Angle		No	No	No
Tilting Angle		Forward tilting : 5° ± 2°; Backward tilting: 15° ± 2°		
Environmental conditions	Action	Temperature: 0°C~ 40°C (32°F ~ 104°F) Humidity: 10%~90% RH (non-condensing)		
	Storage	Temperature: -20°~ 60° (-4°F ~ 140°F) Humidity: 5%~95% RH (non-condensing)		



The above parameters are for reference only, and the parameters of the actual model shall prevail.

Appendix 1 Troubleshooting

Appendix Table 1-1 FAQ

Faults occurring	Possible solutions
The power indicator light is not on	<ul style="list-style-type: none"> ● Check if the power is on. ● Check if the power cord is connected.
Impossible plug-and-play	<ul style="list-style-type: none"> ● Check if the function of plug-and-play of the device is compatible with PC. ● Check if the display card is compatible with the plug-and-play function.
Dimming picture	Adjust brightness and contrast.
Flickering picture or picture with ripples	There may be electrical appliances or equipment with electronic disturbance.
The power indicator light is on (flickering),but the monitor has no pictures.	<ul style="list-style-type: none"> ● Check if the PC power is on. ● Check if the PC display card is inserted properly. ● Check if the signal cable of the monitor is correctly connected with the PC. ● Check the signal cable plug of the monitor and make sure every pin has no bending. ● Observe the indicator light by pressing the Caps Lock key on the PC keyboard and check if the PC is working.
Color shortage (red, green and blue)	Check the signal cable of the monitor and make sure every pin has no bending.
The picture is not in the middle, or the size is not right	Hot key(A UTO)
Picture with color difference (white looks not white)	Adjust RGB color or reselect color temperature.
Screen font blur under VGA signal	Select the "E" to automatically adjust the image.
Screen color error under VGA signal	Select "Auto color" in OSD to correct under the white output screen.



The above workarounds are for reference only. If you have any problems, please contact the after-sales service center or find a professional to help.

Appendix 2 Cybersecurity Recommendations

Cybersecurity is more than just a buzzword: it's something that pertains to every device that is connected to the internet. IP video surveillance is not immune to cyber risks, but taking basic steps toward protecting and strengthening networks and networked appliances will make them less susceptible to attacks. Below are some tips and recommendations from Dahua on how to create a more secured security system.

Mandatory actions to be taken for basic device network security:

1. Use Strong Passwords

Please refer to the following suggestions to set passwords.

- The length should not be less than 8 characters.
- Include at least two types of characters; character types include upper and lower case letters, numbers and symbols.
- Do not contain the account name or the account name in reverse order.
- Do not use continuous characters, such as 123, abc, etc.
- Do not use overlapped characters, such as 111, aaa, etc.

2. Update Firmware and Client Software in Time

- According to the standard procedure in Tech-industry, we recommend to keep your device (such as NVR, DVR, IP camera, etc.) firmware up-to-date to ensure the system is equipped with the latest security patches and fixes. When the device is connected to the public network, it is recommended to enable the "auto-check for updates" function to obtain timely information of firmware updates released by the manufacturer.
- We suggest that you download and use the latest version of client software.

"Nice to have" recommendations to improve your device network security:

1. Physical Protection

We suggest that you perform physical protection to device, especially storage devices. For example, place the device in a special computer room and cabinet, and implement well-done access control permission and key management to prevent unauthorized personnel from carrying out physical contacts such as damaging hardware, unauthorized connection of removable device (such as USB flash disk, serial port), etc.

2. Change Passwords Regularly

We suggest that you change passwords regularly to reduce the risk of being guessed or cracked.

3. Set and Update Passwords Reset Information Timely

The device supports password reset function. Please set up related information for password reset in time, including the end user's mailbox and password protection questions. If the information changes, please modify it in time. When setting password protection questions, it is suggested not to use those that can be easily guessed.

4. Enable Account Lock

The account lock feature is enabled by default, and we recommend you to keep it on to guarantee the account security. If an attacker attempts to log in with the wrong password several times, the corresponding account and the source IP address will be locked.

5. Change Default HTTP and Other Service Ports

We suggest you to change default HTTP and other service ports into any set of numbers between

1024–65535, reducing the risk of outsiders being able to guess which ports you are using.

6. Enable HTTPS

We suggest you to enable HTTPS, so that you visit Web service through a secure communication channel.

7. MAC Address Binding

We recommend you to bind the IP and MAC address of the gateway to the device, thus reducing the risk of ARP spoofing.

8. Assign Accounts and Privileges Reasonably

According to business and management requirements, reasonably add users and assign a minimum set of permissions to them.

9. Disable Unnecessary Services and Choose Secure Modes

If not needed, it is recommended to turn off some services such as SNMP, SMTP, UPnP, etc., to reduce risks.

If necessary, it is highly recommended that you use safe modes, including but not limited to the following services:

- SNMP: Choose SNMP v3, and set up strong encryption passwords and authentication passwords.
- SMTP: Choose TLS to access mailbox server.
- FTP: Choose SFTP, and set up strong passwords.
- AP hotspot: Choose WPA2-PSK encryption mode, and set up strong passwords.

10. Audio and Video Encrypted Transmission

If your audio and video data contents are very important or sensitive, we recommend that you use encrypted transmission function, to reduce the risk of audio and video data being stolen during transmission.

Reminder: encrypted transmission will cause some loss in transmission efficiency.

11. Secure Auditing

- Check online users: we suggest that you check online users regularly to see if the device is logged in without authorization.
- Check device log: By viewing the logs, you can know the IP addresses that were used to log in to your devices and their key operations.

12. Network Log

Due to the limited storage capacity of the device, the stored log is limited. If you need to save the log for a long time, it is recommended that you enable the network log function to ensure that the critical logs are synchronized to the network log server for tracing.

13. Construct a Safe Network Environment

In order to better ensure the safety of device and reduce potential cyber risks, we recommend:

- Disable the port mapping function of the router to avoid direct access to the intranet devices from external network.
- The network should be partitioned and isolated according to the actual network needs. If there are no communication requirements between two sub networks, it is suggested to use VLAN, network GAP and other technologies to partition the network, so as to achieve the network isolation effect.
- Establish the 802.1x access authentication system to reduce the risk of unauthorized access to private networks.

- Enable IP/MAC address filtering function to limit the range of hosts allowed to access the device.

More information

Please visit Dahua official website security emergency response center for security announcements and the latest security recommendations.

ENABLING A SAFER SOCIETY AND SMARTER LIVING

ZHEJIANG DAHUA VISION TECHNOLOGY CO., LTD.

Address: No. 1399, Binxing Road, Binjiang District, Hangzhou, P. R. China | Website: www.dahuasecurity.com | Postcode: 310053

Email: dhoverseas@dhvisiontech.com | Tel: +86-571-87688888 28933188